

HYDGET

LIGHTING

Outdoor Bollard and Wall Light Catalog



HYDGET
恒域

Room 402, No.2 Dongxu Center, Lane 1933, North Zhangyang Road, Pudong New Area, Shanghai
Telephone : +86 21 58660886
Email : sales@hydgetlighting.com



■ 2001— P-W02 ■ 2002— P-W02 ■ 2003— P-W02 ■ 2004— P-W02 ■ 2005— P-W03



■ 2006— P-W03 ■ 2007— P-W03 ■ 2008— P-W03 ■ 2009— P-W04 ■ 2010— P-W04



■ 2011— P-W04 ■ 2012— P-W04 ■ 2013— P-W06 ■ 2014— P-W06 ■ 2015— P-W06



■ 2016— P-W06 ■ 2017N— P-W08 ■ 2018N— P-W08 ■ 2019— P-W08 ■ 2020— P-W08



■ 2021— P-W09 ■ 2022— P-W09 ■ 2025— P-W09 ■ 2026— P-W09 ■ 2027— P-W10



■ 2028— P-W10 ■ 2029— P-W10 ■ 2031— P-W10 ■ 2032— P-W11 ■ 2033— P-W11



■ 2034— P-W11 ■ 2035— P-W11 ■ 2036— P-W12 ■ 2037— P-W12 ■ 2041— P-W12



■ 2043— P-W12 ■ 2048— P-W13 ■ 2049— P-W13 ■ 2055— P-W13 ■ 2056— P-W13



■ 2058— P-W14 ■ 2061— P-W14 ■ 2062— P-W14 ■ 2063— P-W14 ■ 2064— P-W15



■ 2065— P-W15 ■ 2070— P-W16 ■ 2071— P-W16 ■ 2072— P-W16 ■ 2073— P-W16



■ 2074— P-W18 ■ 2075— P-W18 ■ 2089— P-W18 ■ 2090— P-W18 ■ 2092— P-W19



■ 2095— P-W19 ■ 2096— P-W19 ■ 2097— P-W19 ■ 2098— P-W20 ■ 2099— P-W20



■ 2100 — P-W20 ■ 2102 — P-W20 ■ 2105 — P-W21 ■ 2106 — P-W21 ■ 2109 — P-W21



■ 2114 — P-W21 ■ 2110 — P-W22 ■ 2111 — P-W22 ■ 2112 — P-W22 ■ 2113 — P-W22



■ 2122A — P-W23 ■ 2122B — P-W23 ■ 2123A — P-W23 ■ 2123B — P-W23 ■ 2126 — P-W24



■ 2127 — P-W24 ■ 2124 — P-W24 ■ 2125 — P-W25 ■ 2125A — P-W25 ■ 2125B — P-W26



■ 2125C — P-W26 ■ 2125D — P-W26 ■ 2125E — P-W26 ■ 2128 — P-W27 ■ 2129 — P-W27



■ 2131 — P-W28 ■ 2132 — P-W28 ■ 2133 — P-W28 ■ 2134 — P-W28 ■ 2135 — P-W29



■ 2136 — P-W29 ■ 2137 — P-W29 ■ 2137 — P-W29

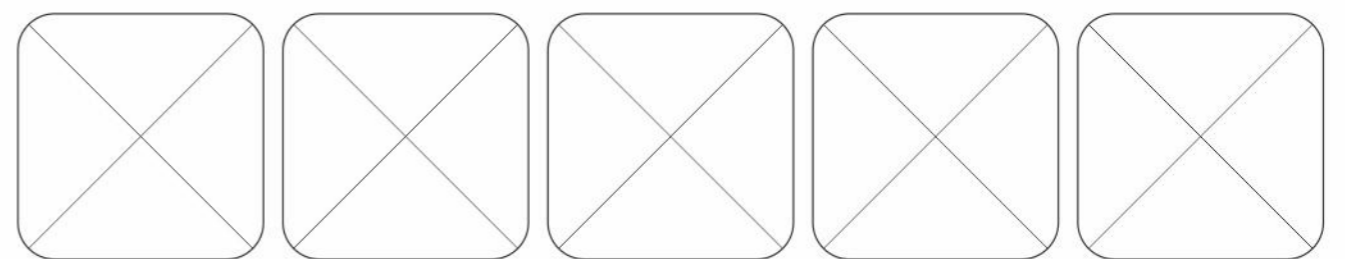



■ 1020 — P-B02 ■ 1021 — P-B02 ■ 1022 — P-B02 ■ 1023 — P-B03 ■ 1024 — P-B03



■ 1024D — P-B03 ■ 1025 — P-B04 ■ 1026 — P-B04 ■ 1028 — P-B04 ■ 1029D — P-B06



■ 1031 — P-B06 ■ 1065 — P-B06 ■ 1034 — P-B07 ■ 1032A — P-B07 ■ 1032B — P-B07



■ 1033A — P-B08 ■ 1033B — P-B08 ■ 1065B — P-B08 ■ 1065T — P-B09 ■ 1065Z — P-B09



■ 1072 — P-B09 ■ 1073 — P-B10 ■ 1071 — P-B10 ■ 1076 — P-B10 ■ 1077 — P-B11



■ 1078 — P-B11 ■ 1079 — P-B11 ■ 1083 — P-B12 ■ 1084 — P-B12 ■ 1093 — P-B13



■ 1095 — P-B13 ■ 1096 — P-B13 ■ 8001 — P-B16 ■ S2130 — P-S01 ■ S1032 — P-S02



■ S1026 — P-S02

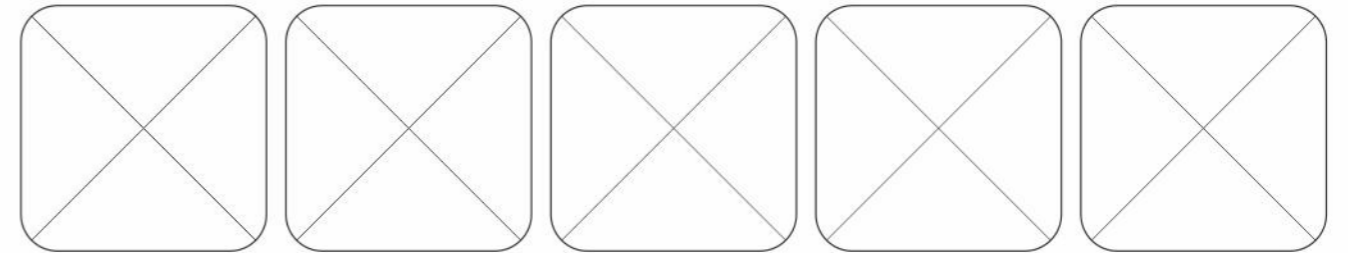

Wall Lighting

Wall Lighting

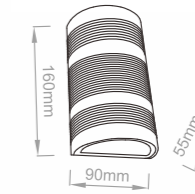
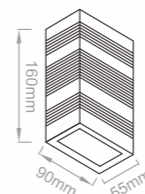

2001

LED 光源	2*3W / 600lm
Color Temperature 色温	2700K / 3000K / 4000K / 6000K
Ra 显指	≥80
Fixture Color 灯体颜色	Black / Grey / White / Platinum grey 砂黑 / 砂灰 / 砂白 / 砂咖啡
Input Voltage 输入电压	AC 100~277V
Working Temperature 工作温度	-15°C ~ 50°C
Material 主要材质	Die-casting aluminum / Tempered glass 压铸铝 / 钢化玻璃

2002

LED 光源	2*3W / 600lm
Color Temperature 色温	2700K / 3000K / 4000K / 6000K
Ra 显指	≥80
Fixture Color 灯体颜色	Black / Grey / White / Platinum grey 砂黑 / 砂灰 / 砂白 / 砂咖啡
Input Voltage 输入电压	AC 100~277V
Working Temperature 工作温度	-15°C ~ 50°C
Material 主要材质	Die-casting aluminum / Tempered glass 压铸铝 / 钢化玻璃

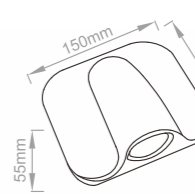
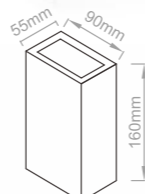

2003

LED 光源	2*3W / 600lm
Color Temperature 色温	2700K / 3000K / 4000K / 6000K
Ra 显指	≥80
Fixture Color 灯体颜色	Black / Grey / White / Platinum grey 砂黑 / 砂灰 / 砂白 / 砂咖啡
Input Voltage 输入电压	AC 100~277V
Working Temperature 工作温度	-15°C ~ 50°C
Material 主要材质	Die-casting aluminum / Tempered glass 压铸铝 / 钢化玻璃

2004

LED 光源	3W / 300lm
Color Temperature 色温	2700K / 3000K / 4000K / 6000K
Ra 显指	≥80
Fixture Color 灯体颜色	Black / Grey / White / Platinum grey 砂黑 / 砂灰 / 砂白 / 砂咖啡
Input Voltage 输入电压	AC 100~277V
Working Temperature 工作温度	-15°C ~ 50°C
Material 主要材质	Die-casting aluminum / Tempered glass 压铸铝 / 钢化玻璃

Wall Lighting



2005

LED 光源	2*3W / 600lm
Color Temperature 色温	2700K / 3000K / 4000K / 6000K
Ra 显指	≥80
Fixture Color 灯体颜色	Black / Grey / White / Platinum grey 砂黑 / 砂灰 / 砂白 / 砂咖啡
Input Votage 输入电压	AC 100~277V
Working Temperature 工作温度	-15°C ~ 50°C
Material 主要材质	Die-casting aluminum / Tempered glass 压铸铝 / 钢化玻璃



2006

LED 光源	2*3W / 600lm
Color Temperature 色温	2700K / 3000K / 4000K / 6000K
Ra 显指	≥80
Fixture Color 灯体颜色	Black / Grey / White / Platinum grey 砂黑 / 砂灰 / 砂白 / 砂咖啡
Input Votage 输入电压	AC 100~277V
Working Temperature 工作温度	-15°C ~ 50°C
Material 主要材质	Die-casting aluminum / Tempered glass 压铸铝 / 钢化玻璃

Wall Lighting



2009

LED 光源	2*3W / 600lm
Color Temperature 色温	2700K / 3000K / 4000K / 6000K
Ra 显指	≥80
Fixture Color 灯体颜色	Black / Grey / White / Platinum grey 砂黑 / 砂灰 / 砂白 / 砂咖啡
Input Votage 输入电压	AC 100~277V
Working Temperature 工作温度	-15°C ~ 50°C
Material 主要材质	Die-casting aluminum / Tempered glass 压铸铝 / 钢化玻璃

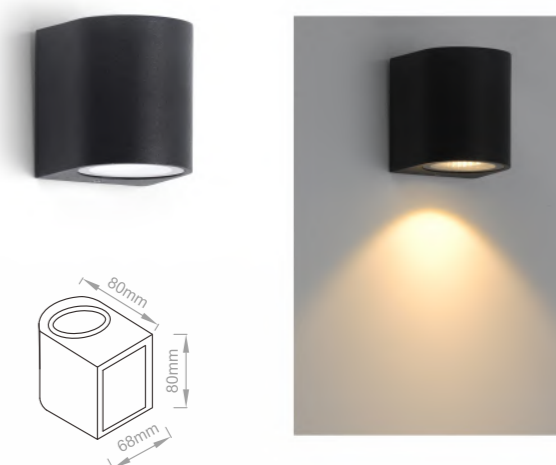

2010

LED 光源	3W / 300lm
Color Temperature 色温	2700K / 3000K / 4000K / 6000K
Ra 显指	≥80
Fixture Color 灯体颜色	Black / Grey / White / Platinum grey 砂黑 / 砂灰 / 砂白 / 砂咖啡
Input Votage 输入电压	AC 100~277V
Working Temperature 工作温度	-15°C ~ 50°C
Material 主要材质	Die-casting aluminum / Tempered glass 压铸铝 / 钢化玻璃



2007

LED 光源	3W / 300lm
Color Temperature 色温	2700K / 3000K / 4000K / 6000K
Ra 显指	≥80
Fixture Color 灯体颜色	Black / Grey / White / Platinum grey 砂黑 / 砂灰 / 砂白 / 砂咖啡
Input Votage 输入电压	AC 100~277V
Working Temperature 工作温度	-15°C ~ 50°C
Material 主要材质	Die-casting aluminum / Tempered glass 压铸铝 / 钢化玻璃

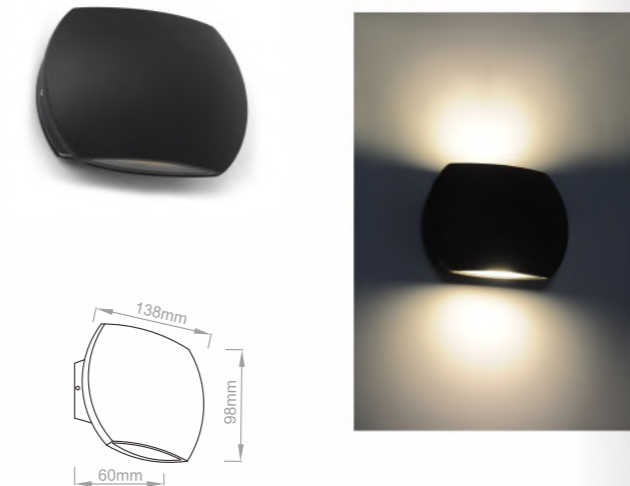

2008

LED 光源	2*3W / 600lm
Color Temperature 色温	2700K / 3000K / 4000K / 6000K
Ra 显指	≥80
Fixture Color 灯体颜色	Black / Grey / White / Platinum grey 砂黑 / 砂灰 / 砂白 / 砂咖啡
Input Votage 输入电压	AC 100~277V
Working Temperature 工作温度	-15°C ~ 50°C
Material 主要材质	Die-casting aluminum / Tempered glass 压铸铝 / 钢化玻璃



2011

LED 光源	2*3W / 600lm
Color Temperature 色温	2700K / 3000K / 4000K / 6000K
Ra 显指	≥80
Fixture Color 灯体颜色	Black / Grey / White / Platinum grey 砂黑 / 砂灰 / 砂白 / 砂咖啡
Input Votage 输入电压	AC 100~277V
Working Temperature 工作温度	-15°C ~ 50°C
Material 主要材质	Die-casting aluminum / Tempered glass 压铸铝 / 钢化玻璃



2012

LED 光源	2*3W / 600lm
Color Temperature 色温	2700K / 3000K / 4000K / 6000K
Ra 显指	≥80
Fixture Color 灯体颜色	Black / Grey / White / Platinum grey 砂黑 / 砂灰 / 砂白 / 砂咖啡
Input Votage 输入电压	AC 100~277V
Working Temperature 工作温度	-15°C ~ 50°C
Material 主要材质	Die-casting aluminum / Tempered glass 压铸铝 / 钢化玻璃

■ Wall Lighting

■ Wall Lighting

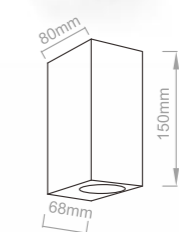
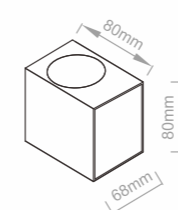

■ 2013

LED 光源	3W / 300lm
Color Temperature 色温	2700K / 3000K / 4000K / 6000K
Ra 显指	≥80
Fixture Color 灯体颜色	Black / Grey / White / Platinum grey 砂黑 / 砂灰 / 砂白 / 砂咖啡
Input Voltage 输入电压	AC 100~277V
Working Temperature 工作温度	-15°C ~ 50°C
Material 主要材质	Die-casting aluminum / Tempered glass 压铸铝 / 钢化玻璃

■ 2014

LED 光源	2*3W / 600lm
Color Temperature 色温	2700K / 3000K / 4000K / 6000K
Ra 显指	≥80
Fixture Color 灯体颜色	Black / Grey / White / Platinum grey 砂黑 / 砂灰 / 砂白 / 砂咖啡
Input Voltage 输入电压	AC 100~277V
Working Temperature 工作温度	-15°C ~ 50°C
Material 主要材质	Die-casting aluminum / Tempered glass 压铸铝 / 钢化玻璃

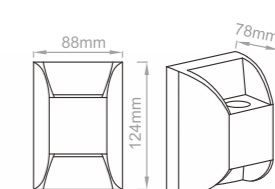
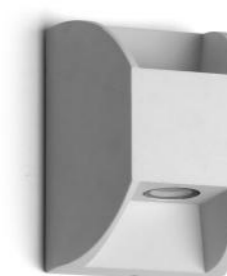
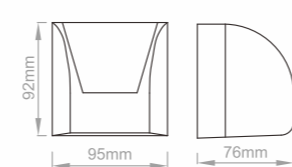

■ 2015

LED 光源	3W / 300lm
Color Temperature 色温	2700K / 3000K / 4000K / 6000K
Ra 显指	≥80
Fixture Color 灯体颜色	Black / Grey / White / Platinum grey 砂黑 / 砂灰 / 砂白 / 砂咖啡
Input Voltage 输入电压	AC 100~277V
Working Temperature 工作温度	-15°C ~ 50°C
Material 主要材质	Die-casting aluminum / Tempered glass 压铸铝 / 钢化玻璃

■ 2016

LED 光源	2*3W / 600lm
Color Temperature 色温	2700K / 3000K / 4000K / 6000K
Ra 显指	≥80
Fixture Color 灯体颜色	Black / Grey / White / Platinum grey 砂黑 / 砂灰 / 砂白 / 砂咖啡
Input Voltage 输入电压	AC 100~277V
Working Temperature 工作温度	-15°C ~ 50°C
Material 主要材质	Die-casting aluminum / Tempered glass 压铸铝 / 钢化玻璃

Wall Lighting



Wall Lighting

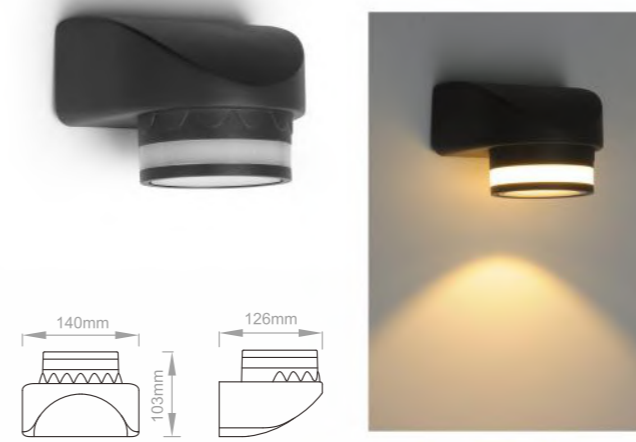

2017N

LED 光源	5W / 500lm
Color Temperature 色温	2700K / 3000K / 4000K / 6000K
Ra 显指	≥80
Fixture Color 灯体颜色	Black / Grey / White / Platinum grey 砂黑 / 砂灰 / 砂白 / 砂咖啡
Input Voltage 输入电压	AC 100-277V
Working Temperature 工作温度	-15°C ~ 50°C
Material 主要材质	Die-casting aluminum Tempered glass / PC diffuser 压铸铝 / 钢化玻璃 / PC

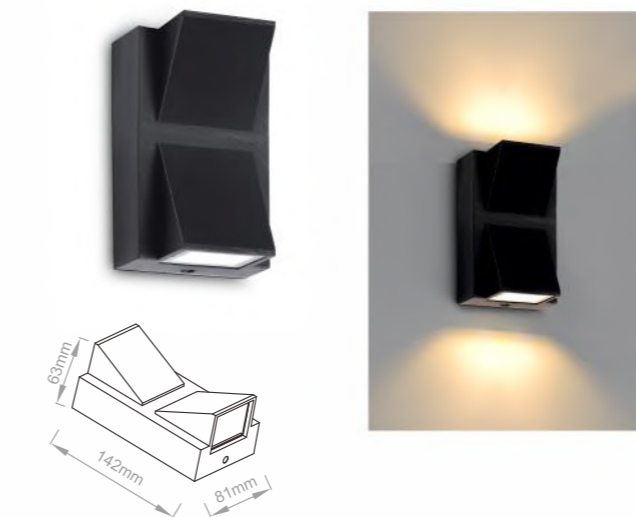

2019

LED 光源	2*3W / 600lm
Color Temperature 色温	2700K / 3000K / 4000K / 6000K
Ra 显指	≥80
Fixture Color 灯体颜色	Black / Grey / White / Platinum grey 砂黑 / 砂灰 / 砂白 / 砂咖啡
Input Voltage 输入电压	AC 100-277V
Working Temperature 工作温度	-15°C ~ 50°C
Material 主要材质	Die-casting aluminum / Tempered glass 压铸铝 / 钢化玻璃



2018N

LED 光源	2*5W / 1000lm
Color Temperature 色温	2700K / 3000K / 4000K / 6000K
Ra 显指	≥80
Fixture Color 灯体颜色	Black / Grey / White / Platinum grey 砂黑 / 砂灰 / 砂白 / 砂咖啡
Input Voltage 输入电压	AC 100-277V
Working Temperature 工作温度	-15°C ~ 50°C
Material 主要材质	Die-casting aluminum Tempered glass / PC diffuser 压铸铝 / 钢化玻璃 / PC



2020

LED 光源	3W / 300lm
Color Temperature 色温	2700K / 3000K / 4000K / 6000K
Ra 显指	≥80
Fixture Color 灯体颜色	Black / Grey / White / Platinum grey 砂黑 / 砂灰 / 砂白 / 砂咖啡
Input Voltage 输入电压	AC 100-277V
Working Temperature 工作温度	-15°C ~ 50°C
Material 主要材质	Die-casting aluminum / Tempered glass 压铸铝 / 钢化玻璃

Wall Lighting

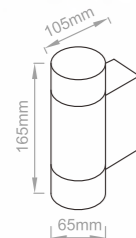

2021

LED 光源	2*3W / 600lm
Color Temperature 色温	2700K / 3000K / 4000K / 6000K
Ra 显指	≥80
Fixture Color 灯体颜色	Black / Grey / White / Platinum grey 砂黑 / 砂灰 / 砂白 / 砂咖啡
Input Voltage 输入电压	AC 100~277V
Working Temperature 工作温度	-15°C ~ 50°C
Material 主要材质	Die-casting aluminum / Tempered glass 压铸铝 / 钢化玻璃

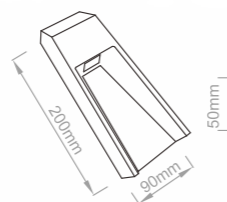

2022

LED 光源	3W / 300lm
Color Temperature 色温	2700K / 3000K / 4000K / 6000K
Ra 显指	≥80
Fixture Color 灯体颜色	Black / Grey / White / Platinum grey 砂黑 / 砂灰 / 砂白 / 砂咖啡
Input Voltage 输入电压	AC 100~277V
Working Temperature 工作温度	-15°C ~ 50°C
Material 主要材质	Die-casting aluminum / Tempered glass 压铸铝 / 钢化玻璃

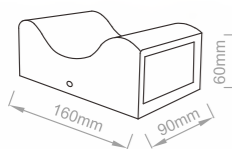

2025

LED 光源	2*3W / 600lm
Color Temperature 色温	2700K / 3000K / 4000K / 6000K
Ra 显指	≥80
Fixture Color 灯体颜色	Black / Grey / White / Platinum grey 砂黑 / 砂灰 / 砂白 / 砂咖啡
Input Voltage 输入电压	AC 100~277V
Working Temperature 工作温度	-15°C ~ 50°C
Material 主要材质	Die-casting aluminum / Tempered glass 压铸铝 / 钢化玻璃

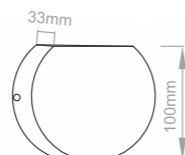

2026

LED 光源	3W / 300lm
Color Temperature 色温	2700K / 3000K / 4000K / 6000K
Ra 显指	≥80
Fixture Color 灯体颜色	Black / Grey / White / Platinum grey 砂黑 / 砂灰 / 砂白 / 砂咖啡
Input Voltage 输入电压	AC 100~277V
Working Temperature 工作温度	-15°C ~ 50°C
Material 主要材质	Die-casting aluminum / Tempered glass 压铸铝 / 钢化玻璃

Wall Lighting

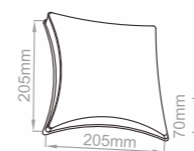
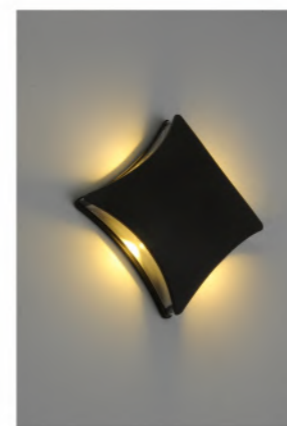

2027

LED 光源	4*2W / 800lm
Color Temperature 色温	2700K / 3000K / 4000K / 6000K
Ra 显指	≥80
Fixture Color 灯体颜色	Black / Grey / White / Platinum grey 砂黑 / 砂灰 / 砂白 / 砂咖啡
Input Voltage 输入电压	AC 100~277V
Working Temperature 工作温度	-15°C ~ 50°C
Material 主要材质	Die-casting aluminum / PC diffuser 压铸铝 / PC

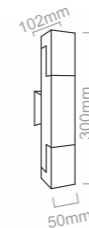

2029

LED 光源	2*3W / 600lm
Color Temperature 色温	2700K / 3000K / 4000K / 6000K
Ra 显指	≥80
Fixture Color 灯体颜色	Black / Grey / White / Platinum grey 砂黑 / 砂灰 / 砂白 / 砂咖啡
Input Voltage 输入电压	AC 100~277V
Working Temperature 工作温度	-15°C ~ 50°C
Material 主要材质	Die-casting aluminum / Acrylic diffuser 压铸铝 / 亚克力

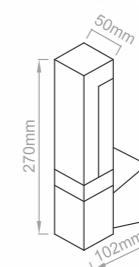

2028

LED 光源	5W / 500lm
Color Temperature 色温	2700K / 3000K / 4000K / 6000K
Ra 显指	≥80
Fixture Color 灯体颜色	Black / Grey / White / Platinum grey 砂黑 / 砂灰 / 砂白 / 砂咖啡
Input Voltage 输入电压	AC 100~277V
Working Temperature 工作温度	-15°C ~ 50°C
Material 主要材质	Die-casting aluminum / Acrylic diffuser 压铸铝 / 亚克力

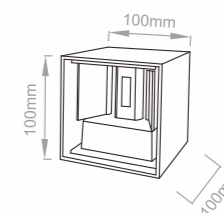

2031

LED 光源	2*3W / 600lm
Color Temperature 色温	2700K / 3000K / 4000K / 6000K
Ra 显指	≥80
Fixture Color 灯体颜色	Black / Grey / White / Platinum grey 砂黑 / 砂灰 / 砂白 / 砂咖啡
Input Voltage 输入电压	AC 100~277V
Working Temperature 工作温度	-15°C ~ 50°C
Material 主要材质	Die-casting aluminum / Tempered glass 压铸铝 / 钢化玻璃

Wall Lighting



2032

LED 光源	4*1.5W / 600lm
Color Temperature 色温	2700K / 3000K / 4000K / 6000K
Ra 显指	≥80
Fixture Color 灯体颜色	Black / Grey / White / Platinum grey 砂黑 / 砂灰 / 砂白 / 砂咖啡
Input Voltage 输入电压	AC 100~277V
Working Temperature 工作温度	-15°C ~ 50°C
Material 主要材质	Die-casting aluminum / PC diffuser 压铸铝 / PC



2033

LED 光源	1W / 100lm
Color Temperature 色温	2700K / 3000K / 4000K / 6000K
Ra 显指	≥80
Fixture Color 灯体颜色	Black / Grey / White / Platinum grey 砂黑 / 砂灰 / 砂白 / 砂咖啡
Input Voltage 输入电压	AC 100~277V
Working Temperature 工作温度	-15°C ~ 50°C
Material 主要材质	Die-casting aluminum / Lens diffuser 压铸铝 / 透镜

Wall Lighting

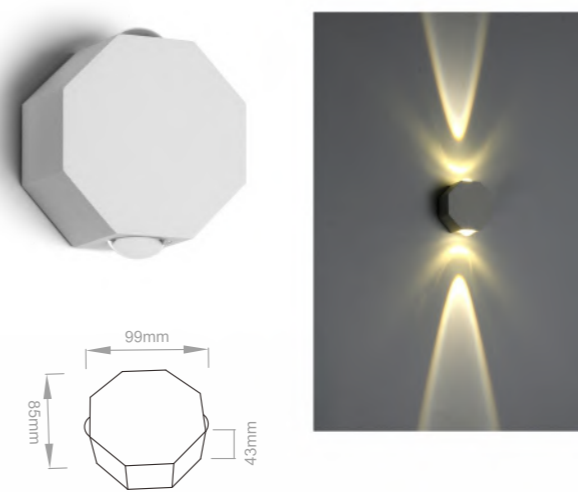

2036

LED 光源	2*3W / 600lm
Color Temperature 色温	2700K / 3000K / 4000K / 6000K
Ra 显指	≥80
Fixture Color 灯体颜色	Black / Grey / White / Platinum grey 砂黑 / 砂灰 / 砂白 / 砂咖啡
Input Voltage 输入电压	AC 100~277V
Working Temperature 工作温度	-15°C ~ 50°C
Material 主要材质	Aluminum / Lens diffuser 铝 / 透镜

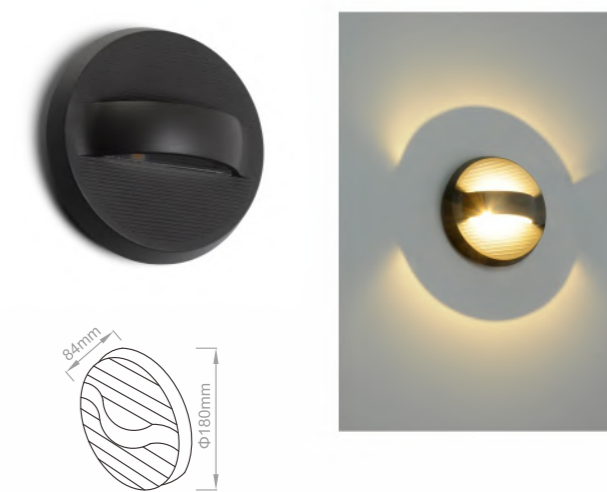

2037

LED 光源	5W / 500lm
Color Temperature 色温	2700K / 3000K / 4000K / 6000K
Ra 显指	≥80
Fixture Color 灯体颜色	Black / Grey / White / Platinum grey 砂黑 / 砂灰 / 砂白 / 砂咖啡
Input Voltage 输入电压	AC 100~277V
Working Temperature 工作温度	-15°C ~ 50°C
Material 主要材质	Die-casting aluminum / PC diffuser 压铸铝 / PC

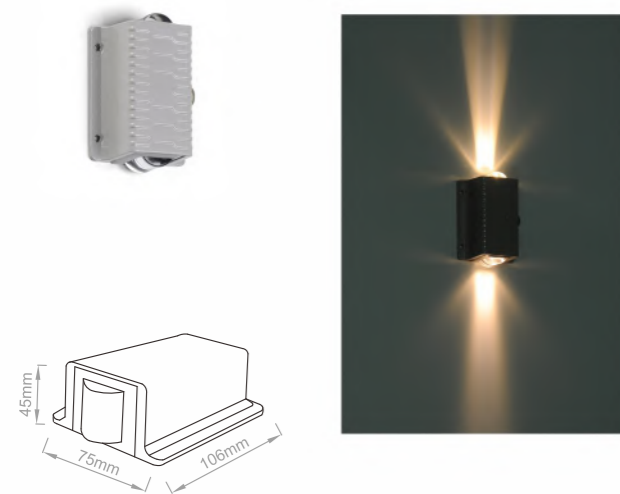

2034

LED 光源	2*1W / 200lm
Color Temperature 色温	2700K / 3000K / 4000K / 6000K
Ra 显指	≥80
Fixture Color 灯体颜色	Black / Grey / White / Platinum grey 砂黑 / 砂灰 / 砂白 / 砂咖啡
Input Voltage 输入电压	AC 100~277V
Working Temperature 工作温度	-15°C ~ 50°C
Material 主要材质	Die-casting aluminum / Lens diffuser 压铸铝 / 透镜

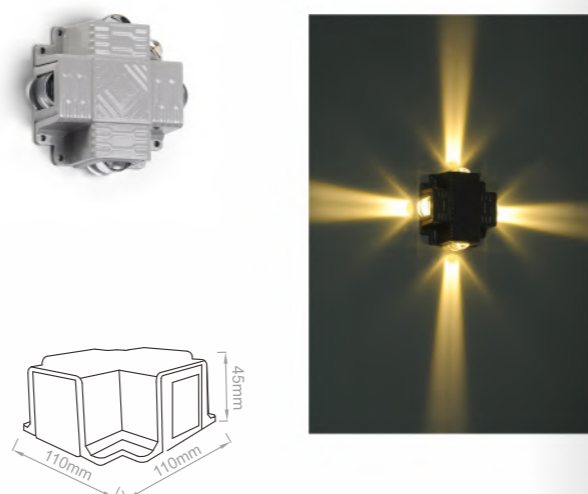

2035

LED 光源	4*1W / 400lm
Color Temperature 色温	2700K / 3000K / 4000K / 6000K
Ra 显指	≥80
Fixture Color 灯体颜色	Black / Grey / White / Platinum grey 砂黑 / 砂灰 / 砂白 / 砂咖啡
Input Voltage 输入电压	AC 100~277V
Working Temperature 工作温度	-15°C ~ 50°C
Material 主要材质	Die-casting aluminum / Lens diffuser 压铸铝 / 透镜



2041

LED 光源	3W / 300lm
Color Temperature 色温	2700K / 3000K / 4000K / 6000K
Ra 显指	≥80
Fixture Color 灯体颜色	Black / Grey / White / Platinum grey 砂黑 / 砂灰 / 砂白 / 砂咖啡
Input Voltage 输入电压	AC 100~277V
Working Temperature 工作温度	-15°C ~ 50°C
Material 主要材质	Die-casting aluminum / Acrylic diffuser 压铸铝 / 亚克力

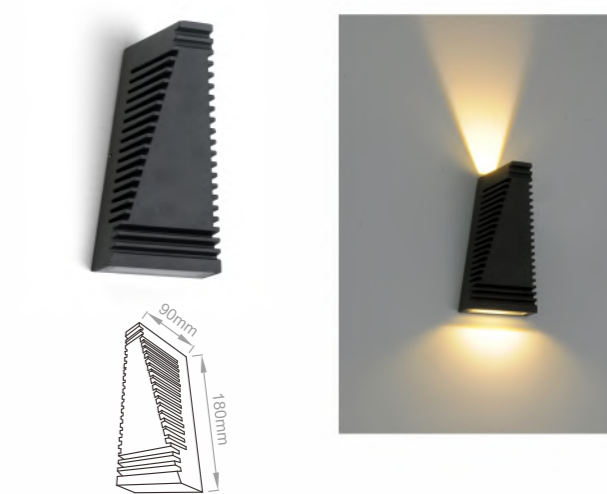

2043

LED 光源	2*3W / 600lm
Color Temperature 色温	2700K / 3000K / 4000K / 6000K
Ra 显指	≥80
Fixture Color 灯体颜色	Black / Grey / White / Platinum grey 砂黑 / 砂灰 / 砂白 / 砂咖啡
Input Voltage 输入电压	AC 100~277V
Working Temperature 工作温度	-15°C ~ 50°C
Material 主要材质	Die-casting aluminum / Tempered glass 压铸铝 / 钢化玻璃

Wall Lighting

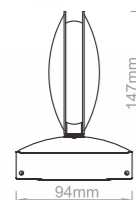

2048

LED 光源	7W / 700lm
Color Temperature 色温	2700K / 3000K / 4000K / 6000K
Ra 显指	≥80
Fixture Color 灯体颜色	Black / Grey / White / Platinum grey 砂黑 / 砂灰 / 砂白 / 砂咖啡
Input Voltage 输入电压	AC 100~277V
Working Temperature 工作温度	-15°C ~ 50°C
Material 主要材质	Die-casting aluminum / Acrylic diffuser 压铸铝 / 亚克力

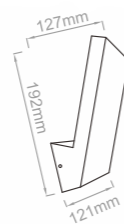
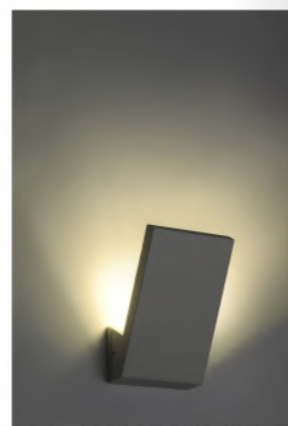

2049

LED 光源	6W / 600lm
Color Temperature 色温	2700K / 3000K / 4000K / 6000K
Ra 显指	≥80
Fixture Color 灯体颜色	Black / Grey / White / Platinum grey 砂黑 / 砂灰 / 砂白 / 砂咖啡
Input Voltage 输入电压	AC 100~277V
Working Temperature 工作温度	-15°C ~ 50°C
Material 主要材质	Die-casting aluminum / Tempered glass 压铸铝 / 钢化玻璃

Wall Lighting

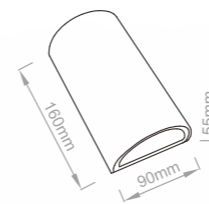

2058

LED 光源	2*3W / 600lm
Color Temperature 色温	2700K / 3000K / 4000K / 6000K
Ra 显指	≥80
Fixture Color 灯体颜色	Black / Grey / White / Platinum grey 砂黑 / 砂灰 / 砂白 / 砂咖啡
Input Voltage 输入电压	AC 100~277V
Working Temperature 工作温度	-15°C ~ 50°C
Material 主要材质	Die-casting aluminum / Tempered glass 压铸铝 / 钢化玻璃

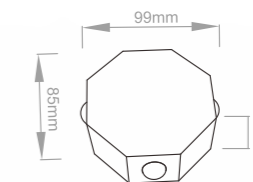
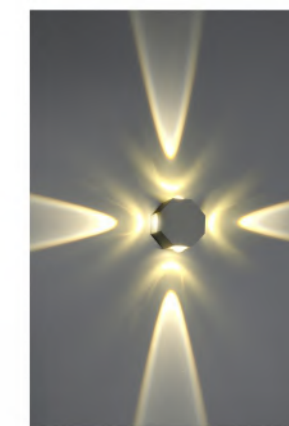
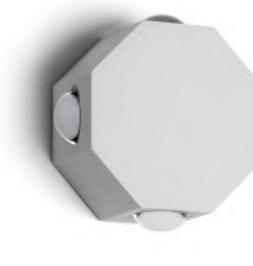

2061

LED 光源	4*3W / 1200lm
Color Temperature 色温	2700K / 3000K / 4000K / 6000K
Ra 显指	≥80
Fixture Color 灯体颜色	Black / Grey / White / Platinum grey 砂黑 / 砂灰 / 砂白 / 砂咖啡
Input Voltage 输入电压	AC 100~277V
Working Temperature 工作温度	-15°C ~ 50°C
Material 主要材质	aluminum / Lens diffuser 铝 / 透镜

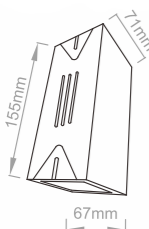

2055

LED 光源	2*3W / 600lm
Color Temperature 色温	2700K / 3000K / 4000K / 6000K
Ra 显指	≥80
Fixture Color 灯体颜色	Black / Grey / White / Platinum grey 砂黑 / 砂灰 / 砂白 / 砂咖啡
Input Voltage 输入电压	AC 100~277V
Working Temperature 工作温度	-15°C ~ 50°C
Material 主要材质	Die-casting aluminum / Tempered glass 压铸铝 / 钢化玻璃

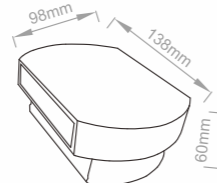

2056

LED 光源	2*3W / 600lm
Color Temperature 色温	2700K / 3000K / 4000K / 6000K
Ra 显指	≥80
Fixture Color 灯体颜色	Black / Grey / White / Platinum grey 砂黑 / 砂灰 / 砂白 / 砂咖啡
Input Voltage 输入电压	AC 100~277V
Working Temperature 工作温度	-15°C ~ 50°C
Material 主要材质	Die-casting aluminum / Tempered glass 压铸铝 / 钢化玻璃

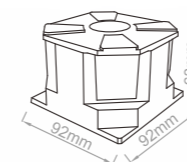
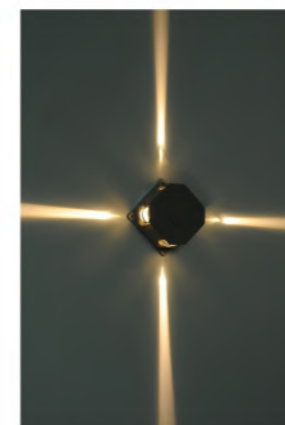
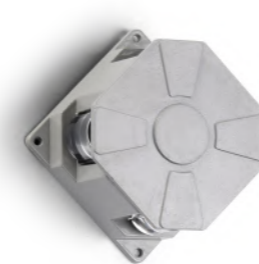

2062

LED 光源	4*1W / 400lm
Color Temperature 色温	2700K / 3000K / 4000K / 6000K
Ra 显指	≥80
Fixture Color 灯体颜色	Black / Grey / White / Platinum grey 砂黑 / 砂灰 / 砂白 / 砂咖啡
Input Voltage 输入电压	AC 100~277V
Working Temperature 工作温度	-15°C ~ 50°C
Material 主要材质	Die-casting aluminum / Lens diffuser 压铸铝 / 透镜

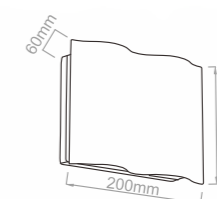

2063

LED 光源	4*1W / 400lm
Color Temperature 色温	2700K / 3000K / 4000K / 6000K
Ra 显指	≥80
Fixture Color 灯体颜色	Black / Grey / White / Platinum grey 砂黑 / 砂灰 / 砂白 / 砂咖啡
Input Voltage 输入电压	AC 100~277V
Working Temperature 工作温度	-15°C ~ 50°C
Material 主要材质	Die-casting aluminum / Lens diffuser 压铸铝 / 透镜

Wall Lighting

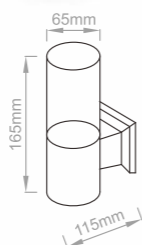
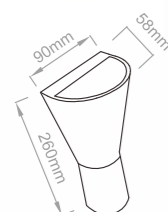

2064

LED 光源	2*3W / 600lm
Color Temperature 色温	2700K / 3000K / 4000K / 6000K
Ra 显指	≥80
Fixture Color 灯体颜色	Black / Grey / White / Platinum grey 砂黑 / 砂灰 / 砂白 / 砂咖啡
Input Voltage 输入电压	AC 100-277V
Working Temperature 工作温度	-15°C ~ 50°C
Material 主要材质	Die-casting aluminum / Tempered glass 压铸铝 / 钢化玻璃

2065

LED 光源	3W / 300lm
Color Temperature 色温	2700K / 3000K / 4000K / 6000K
Ra 显指	≥80
Fixture Color 灯体颜色	Black / Grey / White / Platinum grey 砂黑 / 砂灰 / 砂白 / 砂咖啡
Input Voltage 输入电压	AC 100-277V
Working Temperature 工作温度	-15°C ~ 50°C
Material 主要材质	Die-casting aluminum / Acrylic diffuser 压铸铝 / 亚克力

Wall Lighting

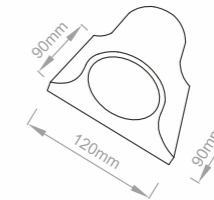
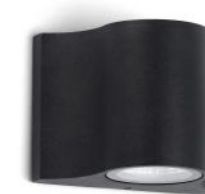
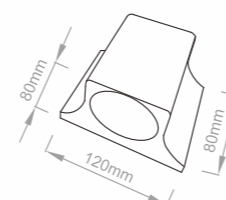

2070

LED 光源	3W / 300lm
Color Temperature 色温	2700K / 3000K / 4000K / 6000K
Ra 显指	≥80
Fixture Color 灯体颜色	Black / Grey / White / Platinum grey 砂黑 / 砂灰 / 砂白 / 砂咖啡
Input Voltage 输入电压	AC 100-277V
Working Temperature 工作温度	-15°C ~ 50°C
Material 主要材质	Die-casting aluminum / Tempered glass 压铸铝 / 钢化玻璃

2071

LED 光源	3W / 300lm
Color Temperature 色温	2700K / 3000K / 4000K / 6000K
Ra 显指	≥80
Fixture Color 灯体颜色	Black / Grey / White / Platinum grey 砂黑 / 砂灰 / 砂白 / 砂咖啡
Input Voltage 输入电压	AC 100-277V
Working Temperature 工作温度	-15°C ~ 50°C
Material 主要材质	Die-casting aluminum / Tempered glass 压铸铝 / 钢化玻璃

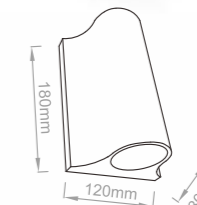
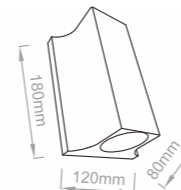

2072

LED 光源	2*3W / 600lm
Color Temperature 色温	2700K / 3000K / 4000K / 6000K
Ra 显指	≥80
Fixture Color 灯体颜色	Black / Grey / White / Platinum grey 砂黑 / 砂灰 / 砂白 / 砂咖啡
Input Voltage 输入电压	AC 100-277V
Working Temperature 工作温度	-15°C ~ 50°C
Material 主要材质	Die-casting aluminum / Tempered glass 压铸铝 / 钢化玻璃

2073

LED 光源	2*3W / 600lm
Color Temperature 色温	2700K / 3000K / 4000K / 6000K
Ra 显指	≥80
Fixture Color 灯体颜色	Black / Grey / White / Platinum grey 砂黑 / 砂灰 / 砂白 / 砂咖啡
Input Voltage 输入电压	AC 100-277V
Working Temperature 工作温度	-15°C ~ 50°C
Material 主要材质	Die-casting aluminum / Tempered glass 压铸铝 / 钢化玻璃

Wall Lighting



Wall Lighting

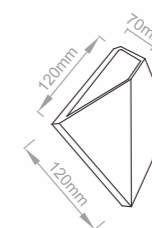
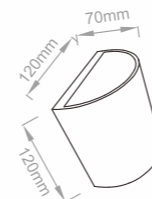

2074

LED 光源	2*3W / 600lm
Color Temperature 色温	2700K / 3000K / 4000K / 6000K
Ra 显指	≥80
Fixture Color 灯体颜色	Black / Grey / White / Platinum grey 砂黑 / 砂灰 / 砂白 / 砂咖啡
Input Voltage 输入电压	AC 100-277V
Working Temperature 工作温度	-15°C ~ 50°C
Material 主要材质	Die-casting aluminum / Tempered glass 压铸铝 / 钢化玻璃

2075

LED 光源	3W / 300lm
Color Temperature 色温	2700K / 3000K / 4000K / 6000K
Ra 显指	≥80
Fixture Color 灯体颜色	Black / Grey / White / Platinum grey 砂黑 / 砂灰 / 砂白 / 砂咖啡
Input Voltage 输入电压	AC 100-277V
Working Temperature 工作温度	-15°C ~ 50°C
Material 主要材质	Die-casting aluminum / Tempered glass 压铸铝 / 钢化玻璃

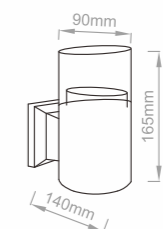
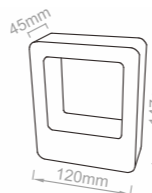

2089

LED 光源	3W / 300lm
Color Temperature 色温	2700K / 3000K / 4000K / 6000K
Ra 显指	≥80
Fixture Color 灯体颜色	Black / Grey / White / Platinum grey 砂黑 / 砂灰 / 砂白 / 砂咖啡
Input Voltage 输入电压	AC 100-277V
Working Temperature 工作温度	-15°C ~ 50°C
Material 主要材质	Die-casting aluminum / Tempered glass 压铸铝 / 钢化玻璃

2090

LED 光源	5W / 500lm
Color Temperature 色温	2700K / 3000K / 4000K / 6000K
Ra 显指	≥80
Fixture Color 灯体颜色	Black / Grey / White / Platinum grey 砂黑 / 砂灰 / 砂白 / 砂咖啡
Input Voltage 输入电压	AC 100-277V
Working Temperature 工作温度	-15°C ~ 50°C
Material 主要材质	Die-casting aluminum / Acrylic diffuser 压铸铝 / 亚克力

Wall Lighting

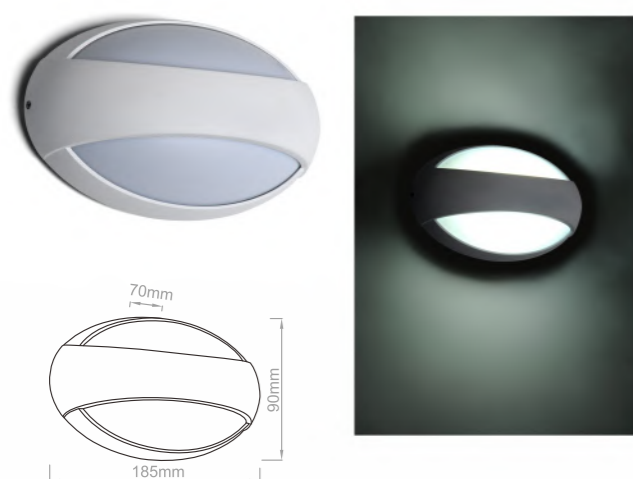

2092

LED 光源	3W / 300lm
Color Temperature 色温	2700K / 3000K / 4000K / 6000K
Ra 显指	≥80
Fixture Color 灯体颜色	Black / Grey / White / Platinum grey 砂黑 / 砂灰 / 砂白 / 砂咖啡
Input Voltage 输入电压	AC 100~277V
Working Temperature 工作温度	-15°C ~ 50°C
Material 主要材质	Die-casting aluminum / PC diffuser 压铸铝 / PC



2095

LED 光源	2*2W / 400lm
Color Temperature 色温	2700K / 3000K / 4000K / 6000K
Ra 显指	≥80
Fixture Color 灯体颜色	Black / Grey / White / Platinum grey 砂黑 / 砂灰 / 砂白 / 砂咖啡
Input Voltage 输入电压	AC 100~277V
Working Temperature 工作温度	-15°C ~ 50°C
Material 主要材质	Die-casting aluminum / Tempered glass 压铸铝 / 钢化玻璃

Wall Lighting

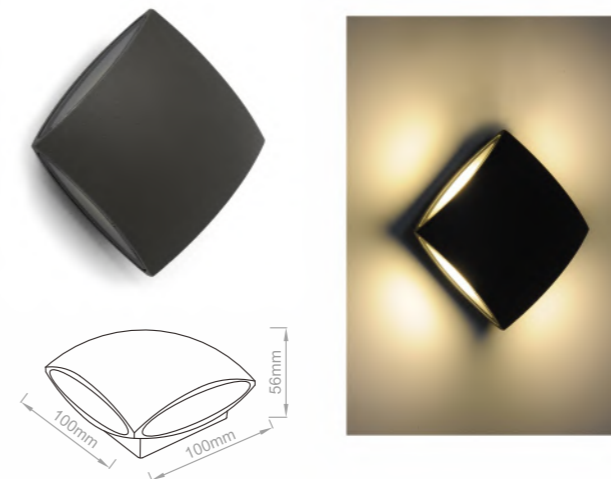

2098

LED 光源	4*1.5W / 600lm
Color Temperature 色温	2700K / 3000K / 4000K / 6000K
Ra 显指	≥80
Fixture Color 灯体颜色	Black / Grey / White / Platinum grey 砂黑 / 砂灰 / 砂白 / 砂咖啡
Input Voltage 输入电压	AC 100~277V
Working Temperature 工作温度	-15°C ~ 50°C
Material 主要材质	Die-casting aluminum / Tempered glass 压铸铝 / 钢化玻璃

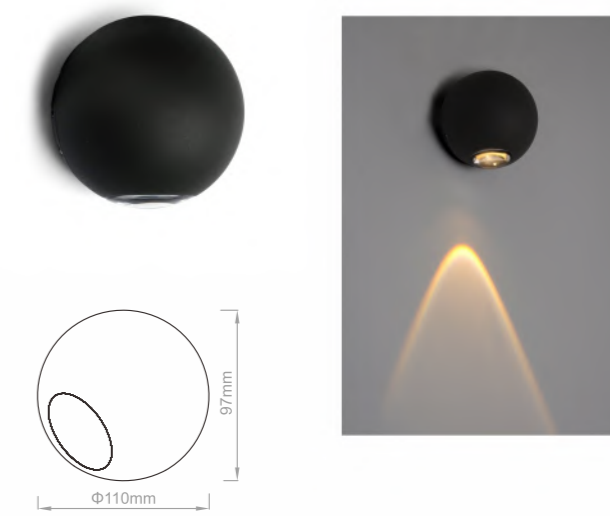

2099

LED 光源	3W / 300lm
Color Temperature 色温	2700K / 3000K / 4000K / 6000K
Ra 显指	≥80
Fixture Color 灯体颜色	Black / Grey / White / Platinum grey 砂黑 / 砂灰 / 砂白 / 砂咖啡
Input Voltage 输入电压	AC 100~277V
Working Temperature 工作温度	-15°C ~ 50°C
Material 主要材质	Die-casting aluminum / Lens diffuser 压铸铝 / 透镜

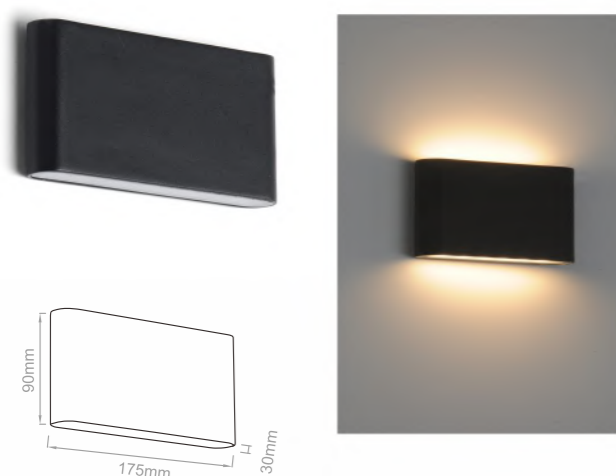

2096

LED 光源	2*3W / 600lm
Color Temperature 色温	2700K / 3000K / 4000K / 6000K
Ra 显指	≥80
Fixture Color 灯体颜色	Black / Grey / White / Platinum grey 砂黑 / 砂灰 / 砂白 / 砂咖啡
Input Voltage 输入电压	AC 100~277V
Working Temperature 工作温度	-15°C ~ 50°C
Material 主要材质	Die-casting aluminum / Tempered glass 压铸铝 / 钢化玻璃

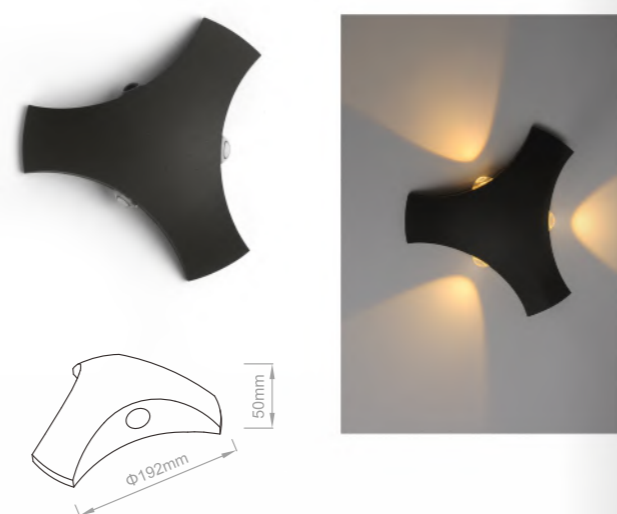

2097

LED 光源	3*1W / 300lm
Color Temperature 色温	2700K / 3000K / 4000K / 6000K
Ra 显指	≥80
Fixture Color 灯体颜色	Black / Grey / White / Platinum grey 砂黑 / 砂灰 / 砂白 / 砂咖啡
Input Voltage 输入电压	AC 100~277V
Working Temperature 工作温度	-15°C ~ 50°C
Material 主要材质	Die-casting aluminum / Lens diffuser 压铸铝 / 透镜

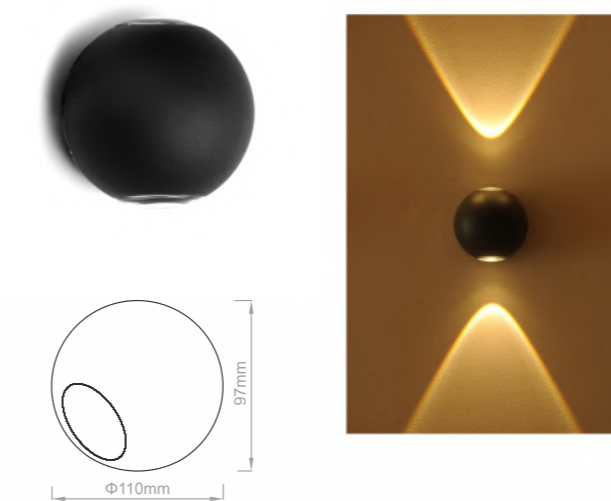

2100

LED 光源	2*3W / 600lm
Color Temperature 色温	2700K / 3000K / 4000K / 6000K
Ra 显指	≥80
Fixture Color 灯体颜色	Black / Grey / White / Platinum grey 砂黑 / 砂灰 / 砂白 / 砂咖啡
Input Voltage 输入电压	AC 100~277V
Working Temperature 工作温度	-15°C ~ 50°C
Material 主要材质	Die-casting aluminum / Lens diffuser 压铸铝 / 透镜

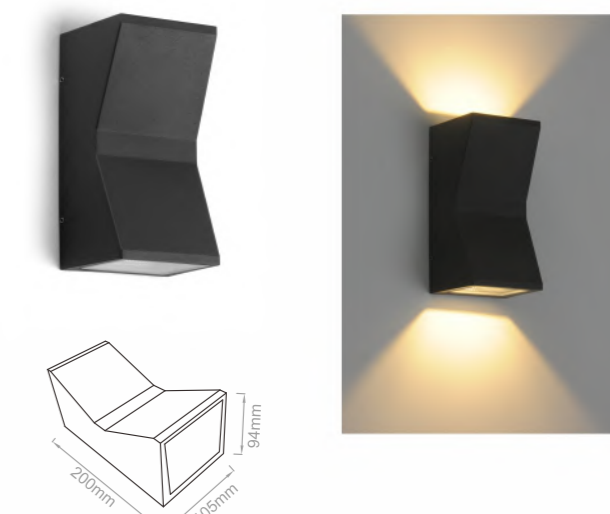

2102

LED 光源	2*5W / 1000lm
Color Temperature 色温	2700K / 3000K / 4000K / 6000K
Ra 显指	≥80
Fixture Color 灯体颜色	Black / Grey / White / Platinum grey 砂黑 / 砂灰 / 砂白 / 砂咖啡
Input Voltage 输入电压	AC 100~277V
Working Temperature 工作温度	-15°C ~ 50°C
Material 主要材质	Die-casting aluminum / Tempered glass 压铸铝 / 钢化玻璃

Wall Lighting



2105

LED 光源	7W / 700lm
Color Temperature 色温	2700K / 3000K / 4000K / 6000K
Ra 显指	≥80
Fixture Color 灯体颜色	Black / Grey / White / Platinum grey 砂黑 / 砂灰 / 砂白 / 砂咖啡
Input Voltage 输入电压	AC 100~277V
Working Temperature 工作温度	-15°C ~ 50°C
Material 主要材质	Aluminum / Tempered glass 铝 / 钢化玻璃



2106

LED 光源	15W / 1500lm
Color Temperature 色温	2700K / 3000K / 4000K / 6000K
Ra 显指	≥80
Fixture Color 灯体颜色	Black / Grey / White / Platinum grey 砂黑 / 砂灰 / 砂白 / 砂咖啡
Input Voltage 输入电压	AC 100~277V
Working Temperature 工作温度	-15°C ~ 50°C
Material 主要材质	Aluminum / Tempered glass 铝 / 钢化玻璃

Wall Lighting

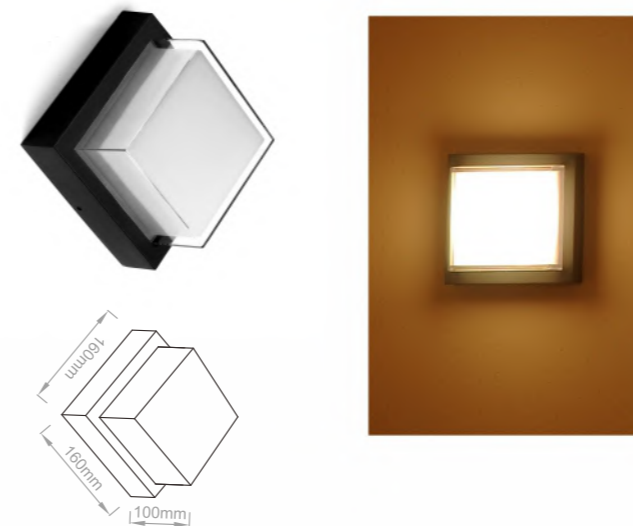

2110

LED 光源	12W / 1200lm
Color Temperature 色温	2700K / 3000K / 4000K / 6000K
Ra 显指	≥80
Fixture Color 灯体颜色	Black / Grey / White / Platinum grey 砂黑 / 砂灰 / 砂白 / 砂咖啡
Input Voltage 输入电压	AC 100~277V
Working Temperature 工作温度	-15°C ~ 50°C
Material 主要材质	Die-casting aluminum / PC diffuser 压铸铝 / PC

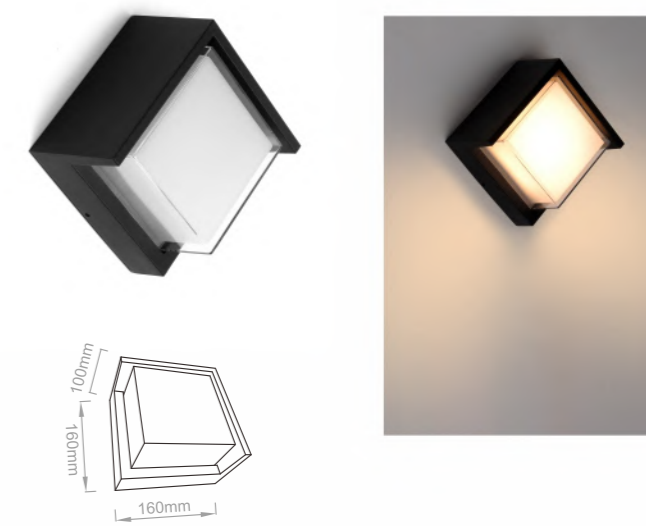

2111

LED 光源	12W / 1200lm
Color Temperature 色温	2700K / 3000K / 4000K / 6000K
Ra 显指	≥80
Fixture Color 灯体颜色	Black / Grey / White / Platinum grey 砂黑 / 砂灰 / 砂白 / 砂咖啡
Input Voltage 输入电压	AC 100~277V
Working Temperature 工作温度	-15°C ~ 50°C
Material 主要材质	Die-casting aluminum / PC diffuser 压铸铝 / PC



2109

LED 光源	2*3W / 600lm
Color Temperature 色温	2700K / 3000K / 4000K / 6000K
Ra 显指	≥80
Fixture Color 灯体颜色	Black / Grey / White / Platinum grey 砂黑 / 砂灰 / 砂白 / 砂咖啡
Input Voltage 输入电压	AC 100~277V
Working Temperature 工作温度	-15°C ~ 50°C
Material 主要材质	Die-casting aluminum Tempered glass / PC diffuser 压铸铝 / 钢化玻璃 / PC

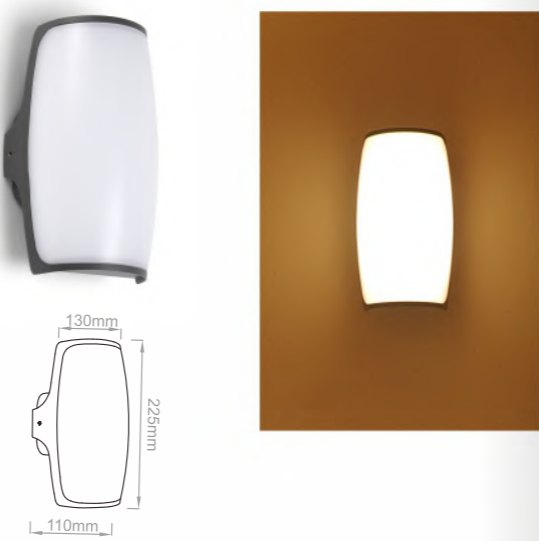

2114

LED 光源	12W / 1200lm
Color Temperature 色温	2700K / 3000K / 4000K / 6000K
Ra 显指	≥80
Fixture Color 灯体颜色	Black / Grey / White / Platinum grey 砂黑 / 砂灰 / 砂白 / 砂咖啡
Input Voltage 输入电压	AC 100~277V
Working Temperature 工作温度	-15°C ~ 50°C
Material 主要材质	Die-casting aluminum / PC diffuser 压铸铝 / PC

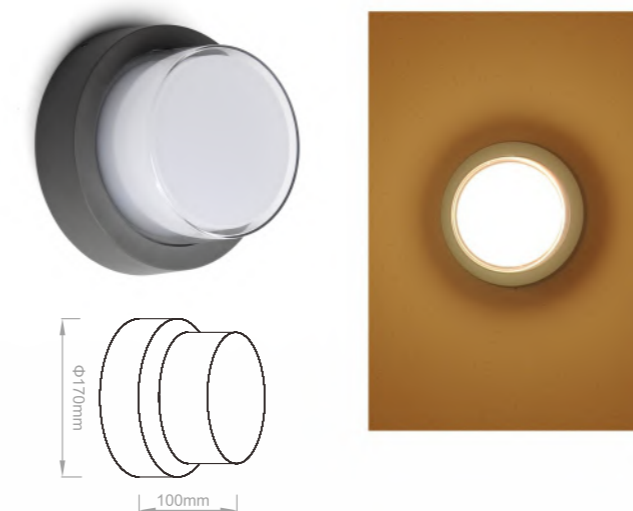

2112

LED 光源	12W / 1200lm
Color Temperature 色温	2700K / 3000K / 4000K / 6000K
Ra 显指	≥80
Fixture Color 灯体颜色	Black / Grey / White / Platinum grey 砂黑 / 砂灰 / 砂白 / 砂咖啡
Input Voltage 输入电压	AC 100~277V
Working Temperature 工作温度	-15°C ~ 50°C
Material 主要材质	Die-casting aluminum / PC diffuser 压铸铝 / PC



2113

LED 光源	12W / 1200lm
Color Temperature 色温	2700K / 3000K / 4000K / 6000K
Ra 显指	≥80
Fixture Color 灯体颜色	Black / Grey / White / Platinum grey 砂黑 / 砂灰 / 砂白 / 砂咖啡
Input Voltage 输入电压	AC 100~277V
Working Temperature 工作温度	-15°C ~ 50°C
Material 主要材质	Die-casting aluminum / PC diffuser 压铸铝 / PC

Wall Lighting

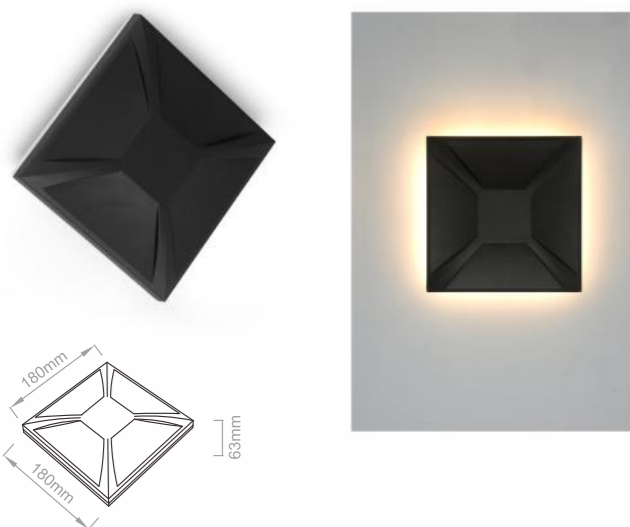

2122A

LED 光源	12W / 1200lm
Color Temperature 色温	2700K / 3000K / 4000K / 6000K
Ra 显指	≥80
Fixture Color 灯体颜色	Black / Grey / White / Platinum grey 砂黑 / 砂灰 / 砂白 / 砂咖啡
Input Voltage 输入电压	AC 100-277V
Working Temperature 工作温度	-15°C ~ 50°C
Material 主要材质	Die-casting aluminum / PC diffuser 压铸铝 / PC

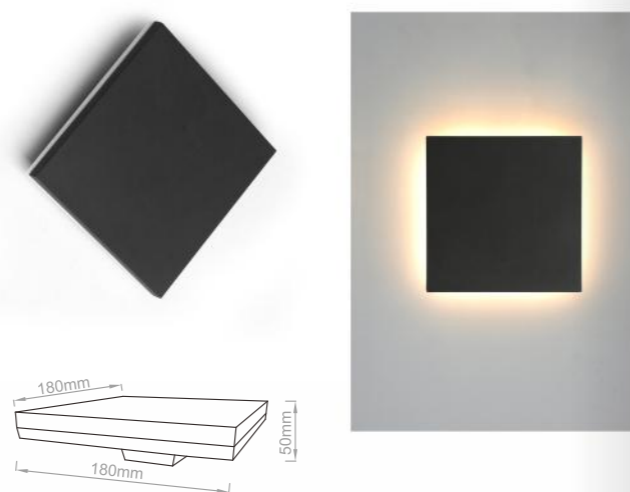

2122B

LED 光源	12W / 1200lm
Color Temperature 色温	2700K / 3000K / 4000K / 6000K
Ra 显指	≥80
Fixture Color 灯体颜色	Black / Grey / White / Platinum grey 砂黑 / 砂灰 / 砂白 / 砂咖啡
Input Voltage 输入电压	AC 100-277V
Working Temperature 工作温度	-15°C ~ 50°C
Material 主要材质	Die-casting aluminum / PC diffuser 压铸铝 / PC

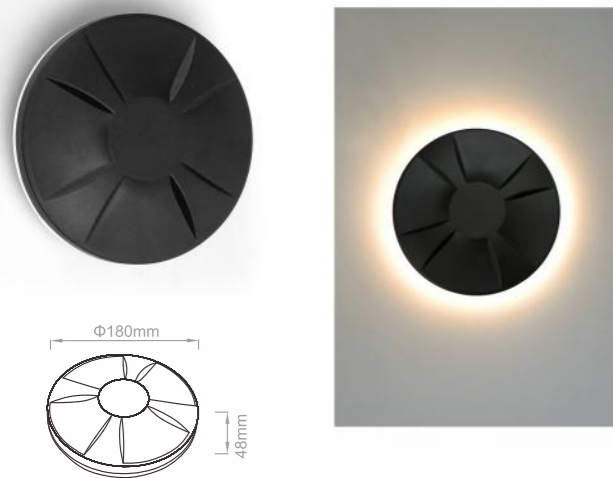

2123A

LED 光源	12W / 1200lm
Color Temperature 色温	2700K / 3000K / 4000K / 6000K
Ra 显指	≥80
Fixture Color 灯体颜色	Black / Grey / White / Platinum grey 砂黑 / 砂灰 / 砂白 / 砂咖啡
Input Voltage 输入电压	AC 100-277V
Working Temperature 工作温度	-15°C ~ 50°C
Material 主要材质	Die-casting aluminum / PC diffuser 压铸铝 / PC

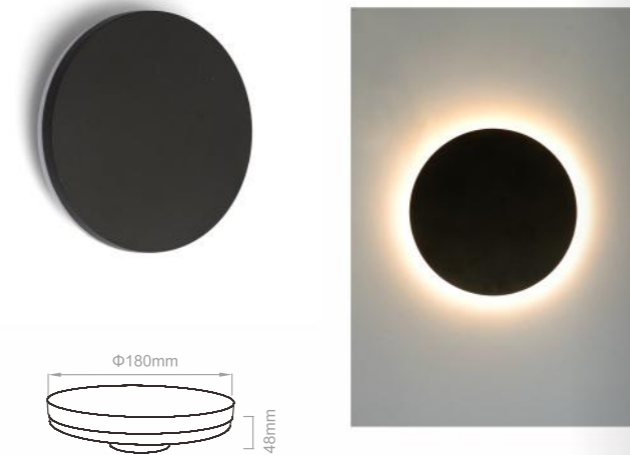

2123B

LED 光源	12W / 1200lm
Color Temperature 色温	2700K / 3000K / 4000K / 6000K
Ra 显指	≥80
Fixture Color 灯体颜色	Black / Grey / White / Platinum grey 砂黑 / 砂灰 / 砂白 / 砂咖啡
Input Voltage 输入电压	AC 100-277V
Working Temperature 工作温度	-15°C ~ 50°C
Material 主要材质	Die-casting aluminum / PC diffuser 压铸铝 / PC

Wall Lighting

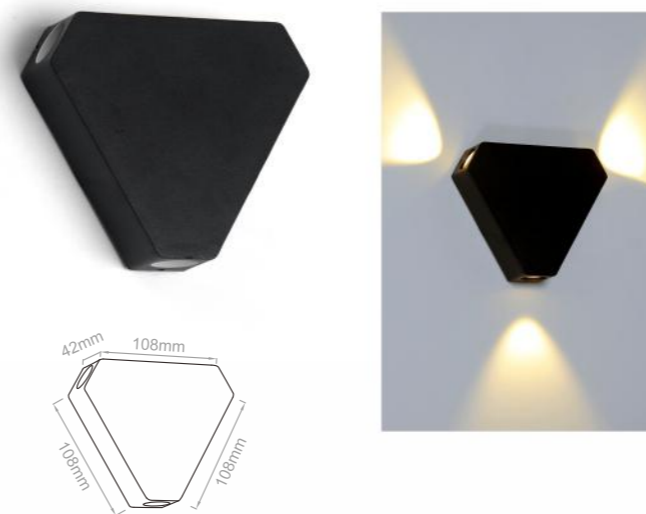

2126

LED 光源	3*1W / 300lm
Color Temperature 色温	2700K / 3000K / 4000K / 6000K
Ra 显指	≥80
Fixture Color 灯体颜色	Black / Grey / White / Platinum grey 砂黑 / 砂灰 / 砂白 / 砂咖啡
Input Voltage 输入电压	AC 100-277V
Working Temperature 工作温度	-15°C ~ 50°C
Material 主要材质	Die-casting aluminum / Tempered glass 压铸铝 / 钢化玻璃

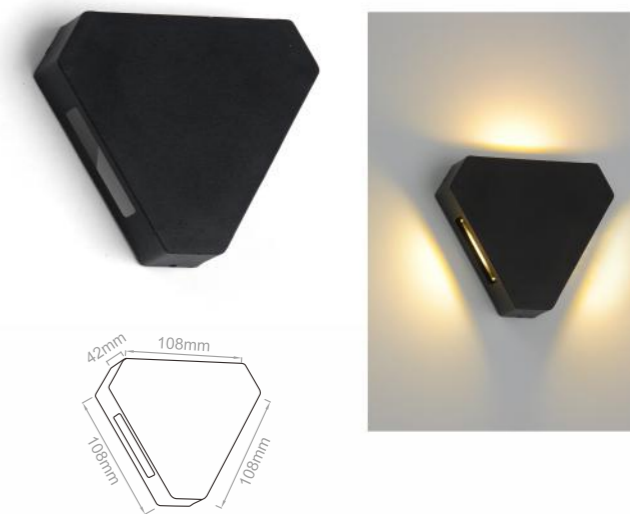

2127

LED 光源	3*1W / 300lm
Color Temperature 色温	2700K / 3000K / 4000K / 6000K
Ra 显指	≥80
Fixture Color 灯体颜色	Black / Grey / White / Platinum grey 砂黑 / 砂灰 / 砂白 / 砂咖啡
Input Voltage 输入电压	AC 100-277V
Working Temperature 工作温度	-15°C ~ 50°C
Material 主要材质	Die-casting aluminum / Tempered glass 压铸铝 / 钢化玻璃

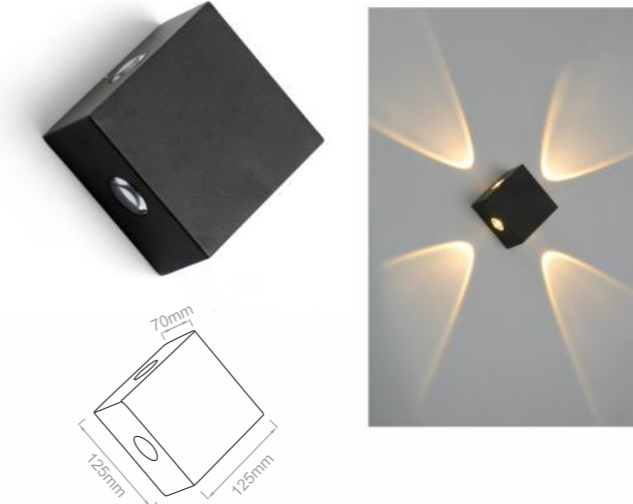

2124

LED 光源	4*1W / 400lm
Color Temperature 色温	2700K / 3000K / 4000K / 6000K
Ra 显指	≥80
Fixture Color 灯体颜色	Black / Grey / White / Platinum grey 砂黑 / 砂灰 / 砂白 / 砂咖啡
Input Voltage 输入电压	AC 100-277V
Working Temperature 工作温度	-15°C ~ 50°C
Material 主要材质	Die-casting aluminum / Lens diffuser 压铸铝 / 透镜



Wall Lighting



Wall Lighting

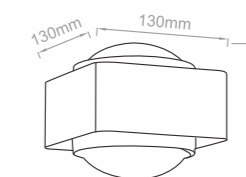
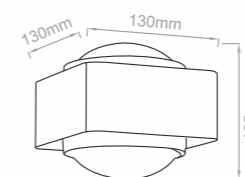

2125B

LED 光源	2*3W / 600lm
Color Temperature 色温	2700K / 3000K / 4000K / 6000K
Ra 显指	≥80
Fixture Color 灯体颜色	Black / Grey / White / Platinum grey 砂黑 / 砂灰 / 砂白 / 砂咖啡
Input Voltage 输入电压	AC 100~277V
Working Temperature 工作温度	-15°C ~ 50°C
Material 主要材质	aluminum / Lens diffuser 铝 / 透镜

2125C

LED 光源	2*3W / 600lm
Color Temperature 色温	2700K / 3000K / 4000K / 6000K
Ra 显指	≥80
Fixture Color 灯体颜色	Black / Grey / White / Platinum grey 砂黑 / 砂灰 / 砂白 / 砂咖啡
Input Voltage 输入电压	AC 100~277V
Working Temperature 工作温度	-15°C ~ 50°C
Material 主要材质	aluminum / Lens diffuser 铝 / 透镜

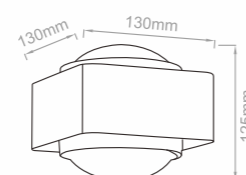
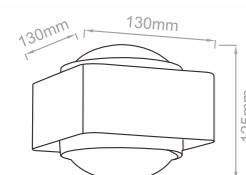

2125

LED 光源	2*3W / 600lm
Color Temperature 色温	2700K / 3000K / 4000K / 6000K
Ra 显指	≥80
Fixture Color 灯体颜色	Black / Grey / White / Platinum grey 砂黑 / 砂灰 / 砂白 / 砂咖啡
Input Voltage 输入电压	AC 100~277V
Working Temperature 工作温度	-15°C ~ 50°C
Material 主要材质	aluminum / Lens diffuser 铝 / 透镜

2125A

LED 光源	2*3W / 600lm
Color Temperature 色温	2700K / 3000K / 4000K / 6000K
Ra 显指	≥80
Fixture Color 灯体颜色	Black / Grey / White / Platinum grey 砂黑 / 砂灰 / 砂白 / 砂咖啡
Input Voltage 输入电压	AC 100~277V
Working Temperature 工作温度	-15°C ~ 50°C
Material 主要材质	aluminum / Lens diffuser 铝 / 透镜

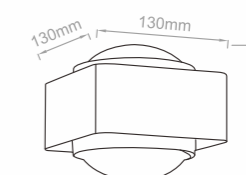
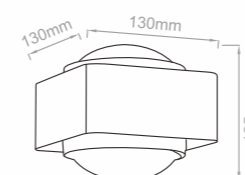

2125D

LED 光源	2*3W / 600lm
Color Temperature 色温	2700K / 3000K / 4000K / 6000K
Ra 显指	≥80
Fixture Color 灯体颜色	Black / Grey / White / Platinum grey 砂黑 / 砂灰 / 砂白 / 砂咖啡
Input Voltage 输入电压	AC 100~277V
Working Temperature 工作温度	-15°C ~ 50°C
Material 主要材质	aluminum / Lens diffuser 铝 / 透镜

2125E

LED 光源	2*3W / 600lm
Color Temperature 色温	2700K / 3000K / 4000K / 6000K
Ra 显指	≥80
Fixture Color 灯体颜色	Black / Grey / White / Platinum grey 砂黑 / 砂灰 / 砂白 / 砂咖啡
Input Voltage 输入电压	AC 100~277V
Working Temperature 工作温度	-15°C ~ 50°C
Material 主要材质	aluminum / Lens diffuser 铝 / 透镜

Wall Lighting



2128

LED 光源	6W / 600lm
Color Temperature 色温	2700K / 3000K / 4000K / 6000K
Ra 显指	≥80
Fixture Color 灯体颜色	Black / Grey / White / Platinum grey 砂黑 / 砂灰 / 砂白 / 砂咖啡
Input Voltage 输入电压	AC 100-277V
Working Temperature 工作温度	-15°C ~ 50°C
Material 主要材质	Die-casting aluminum / PC diffuser 压铸铝 / PC

2129

LED 光源	2*6W / 1200lm
Color Temperature 色温	2700K / 3000K / 4000K / 6000K
Ra 显指	≥80
Fixture Color 灯体颜色	Black / Grey / White / Platinum grey 砂黑 / 砂灰 / 砂白 / 砂咖啡
Input Voltage 输入电压	AC 100-277V
Working Temperature 工作温度	-15°C ~ 50°C
Material 主要材质	Die-casting aluminum / PC diffuser 压铸铝 / PC

Wall Lighting

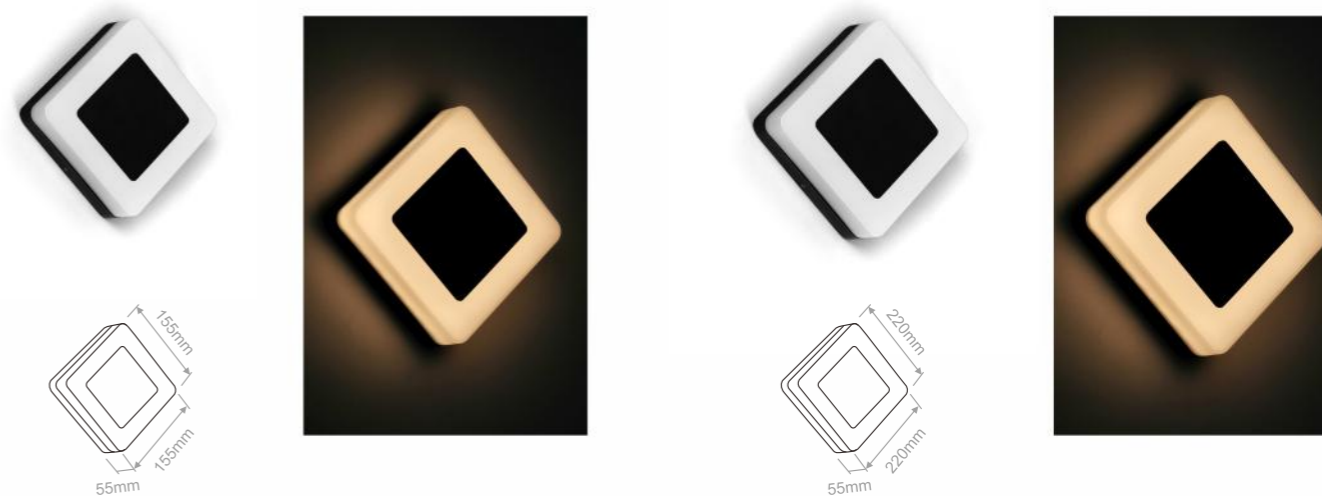

2131

LED 光源	6W / 600lm
Color Temperature 色温	2700K / 3000K / 4000K / 6000K
Ra 显指	≥80
Fixture Color 灯体颜色	Black / Grey / White / Platinum grey 砂黑 / 砂灰 / 砂白 / 砂咖啡
Input Voltage 输入电压	AC 100-277V
Working Temperature 工作温度	-15°C ~ 50°C
Material 主要材质	Die-casting aluminum / PC diffuser 压铸铝 / PC

2132

LED 光源	12W / 1200lm
Color Temperature 色温	2700K / 3000K / 4000K / 6000K
Ra 显指	≥80
Fixture Color 灯体颜色	Black / Grey / White / Platinum grey 砂黑 / 砂灰 / 砂白 / 砂咖啡
Input Voltage 输入电压	AC 100-277V
Working Temperature 工作温度	-15°C ~ 50°C
Material 主要材质	Die-casting aluminum / PC diffuser 压铸铝 / PC

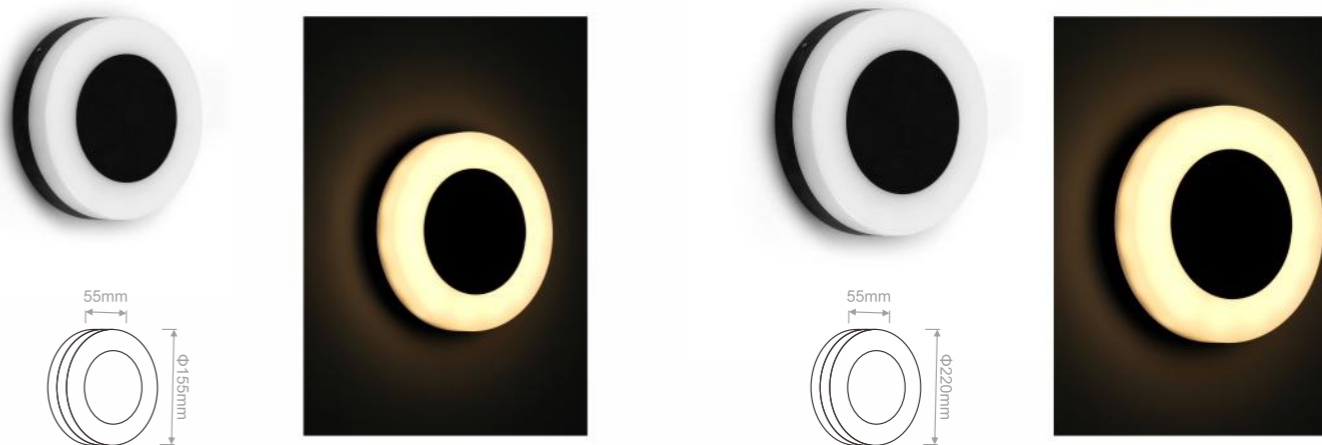

2133

LED 光源	6W / 600lm
Color Temperature 色温	2700K / 3000K / 4000K / 6000K
Ra 显指	≥80
Fixture Color 灯体颜色	Black / Grey / White / Platinum grey 砂黑 / 砂灰 / 砂白 / 砂咖啡
Input Voltage 输入电压	AC 100-277V
Working Temperature 工作温度	-15°C ~ 50°C
Material 主要材质	Die-casting aluminum / PC diffuser 压铸铝 / PC

2134

LED 光源	12W / 1200lm
Color Temperature 色温	2700K / 3000K / 4000K / 6000K
Ra 显指	≥80
Fixture Color 灯体颜色	Black / Grey / White / Platinum grey 砂黑 / 砂灰 / 砂白 / 砂咖啡
Input Voltage 输入电压	AC 100-277V
Working Temperature 工作温度	-15°C ~ 50°C
Material 主要材质	Die-casting aluminum / PC diffuser 压铸铝 / PC

■ Wall Lighting



■ 2135

LED 光源	2*5W / 1000lm
Color Temperature 色温	2700K / 3000K / 4000K / 6000K
Ra 显指	≥80
Fixture Color 灯体颜色	Black / Grey / White / Platinum grey 砂黑 / 砂灰 / 砂白 / 砂咖啡
Input Voltage 输入电压	AC 100-277V
Working Temperature 工作温度	-15°C ~ 50°C
Material 主要材质	Die-casting aluminum / Tempered glass 压铸铝 / 钢化玻璃

■ 2136

LED 光源	2*5W / 1000lm
Color Temperature 色温	2700K / 3000K / 4000K / 6000K
Ra 显指	≥80
Fixture Color 灯体颜色	Black / Grey / White / Platinum grey 砂黑 / 砂灰 / 砂白 / 砂咖啡
Input Voltage 输入电压	AC 100-277V
Working Temperature 工作温度	-15°C ~ 50°C
Material 主要材质	Die-casting aluminum / Tempered glass 压铸铝 / 钢化玻璃

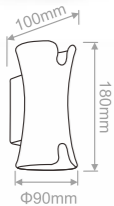

■ 2137

LED 光源	2*5W / 1000lm
Color Temperature 色温	2700K / 3000K / 4000K / 6000K
Ra 显指	≥80
Fixture Color 灯体颜色	Black / Grey / White / Platinum grey 砂黑 / 砂灰 / 砂白 / 砂咖啡
Input Voltage 输入电压	AC 100-277V
Working Temperature 工作温度	-15°C ~ 50°C
Material 主要材质	Aluminum / Tempered glass 铝 / 钢化玻璃

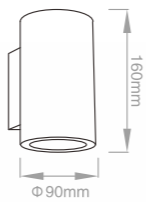

■ 2150

LED 光源	2*5W / 1000lm
Color Temperature 色温	2700K / 3000K / 4000K / 6000K
Ra 显指	≥80
Fixture Color 灯体颜色	Black / Grey / White / Platinum grey 砂黑 / 砂灰 / 砂白 / 砂咖啡
Input Voltage 输入电压	AC 100-277V
Working Temperature 工作温度	-15°C ~ 50°C
Material 主要材质	Aluminum / Lens / Tempered glass 铝 / 透镜 / 钢化玻璃

■ Wall Lighting



■ Bollard Lighting



■ Bollard Lighting



■ 1020

LED 光源	5W / 500lm
Ra 显指	≥ 80
Color Temperature 色温	2700K / 3000K / 4000K / 6000K
Fixture Color 灯体颜色	Black / Grey / White / Platinum grey 砂黑 / 砂灰 / 砂白 / 砂咖啡
Input Voltage 输入电压	AC 100-277V
Working Temperature 工作温度	-15°C ~ 50°C
Material 主要材质	Die-casting aluminum / Tempered glass 压铸铝 / 钢化玻璃

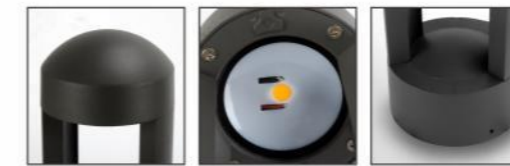
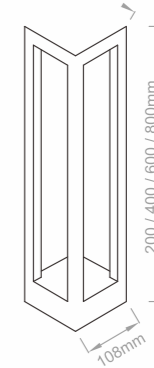

■ 1021

LED 光源	5W / 500lm
Ra 显指	≥ 80
Color Temperature 色温	2700K / 3000K / 4000K / 6000K
Fixture Color 灯体颜色	Black / Grey / White / Platinum grey 砂黑 / 砂灰 / 砂白 / 砂咖啡
Input Voltage 输入电压	AC 100-277V
Working Temperature 工作温度	-15°C ~ 50°C
Material 主要材质	Die-casting aluminum / Tempered glass 压铸铝 / 钢化玻璃

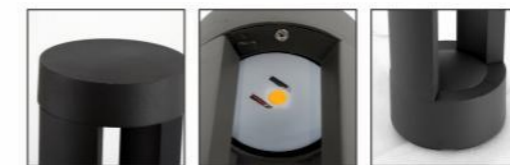
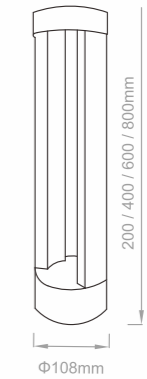

■ 1022

LED 光源	5W / 500lm
Ra 显指	≥ 80
Color Temperature 色温	2700K / 3000K / 4000K / 6000K
Fixture Color 灯体颜色	Black / Grey / White / Platinum grey 砂黑 / 砂灰 / 砂白 / 砂咖啡
Input Voltage 输入电压	AC 100-277V
Working Temperature 工作温度	-15°C ~ 50°C
Material 主要材质	Die-casting aluminum / Tempered glass 压铸铝 / 钢化玻璃

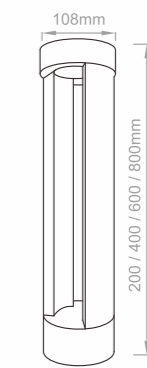

■ Bollard Lighting



■ 1023

LED 光源	5W / 500lm
Ra 显指	≥80
Color Temperature 色温	2700K / 3000K / 4000K / 6000K
Fixture Color 灯体颜色	Black / Grey / White / Platinum grey 砂黑 / 砂灰 / 砂白 / 砂咖啡
Input Voltage 输入电压	AC 100-277V
Working Temperature 工作温度	-15°C ~ 50°C
Material 主要材质	Die-casting aluminum / Tempered glass 压铸铝 / 钢化玻璃

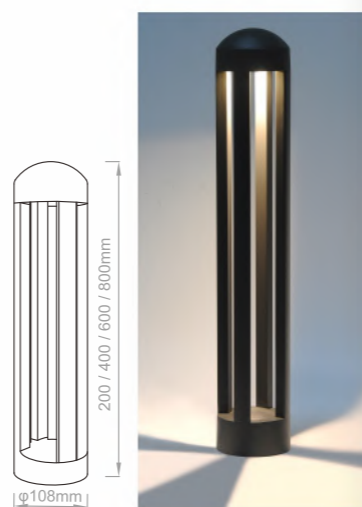

■ Bollard Lighting



■ 1025

LED 光源	5W / 500lm
Ra 显指	≥80
Color Temperature 色温	2700K / 3000K / 4000K / 6000K
Fixture Color 灯体颜色	Black / Grey / White / Platinum grey 砂黑 / 砂灰 / 砂白 / 砂咖啡
Input Voltage 输入电压	AC 100-277V
Working Temperature 工作温度	-15°C ~ 50°C
Material 主要材质	Die-casting aluminum / Tempered glass 压铸铝 / 钢化玻璃

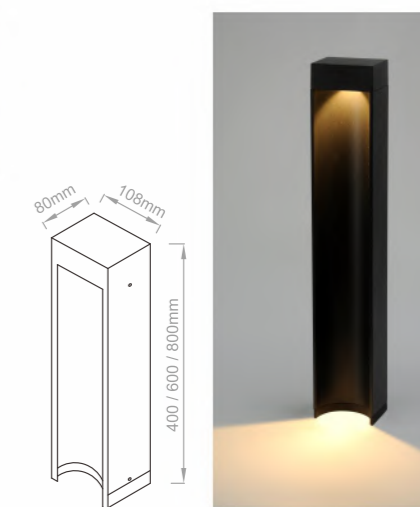

■ 1024

LED 光源	5W / 500lm
Ra 显指	≥80
Color Temperature 色温	2700K / 3000K / 4000K / 6000K
Fixture Color 灯体颜色	Black / Grey / White / Platinum grey 砂黑 / 砂灰 / 砂白 / 砂咖啡
Input Voltage 输入电压	AC 100-277V
Working Temperature 工作温度	-15°C ~ 50°C
Material 主要材质	Die-casting aluminum / Tempered glass 压铸铝 / 钢化玻璃

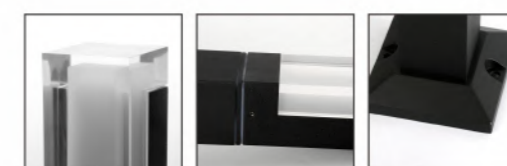
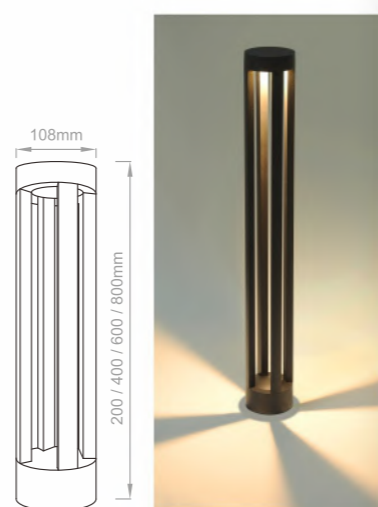

■ 1026

LED 光源	5W / 500lm
Ra 显指	≥80
Color Temperature 色温	2700K / 3000K / 4000K / 6000K
Fixture Color 灯体颜色	Black / Grey / White / Platinum grey 砂黑 / 砂灰 / 砂白 / 砂咖啡
Input Voltage 输入电压	AC 100-277V
Working Temperature 工作温度	-15°C ~ 50°C
Material 主要材质	Die-casting aluminum / Acrylic diffuser 压铸铝 / 亚克力

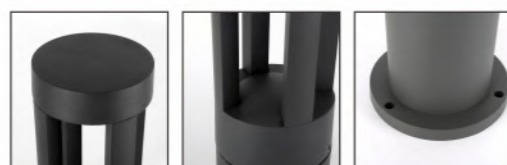
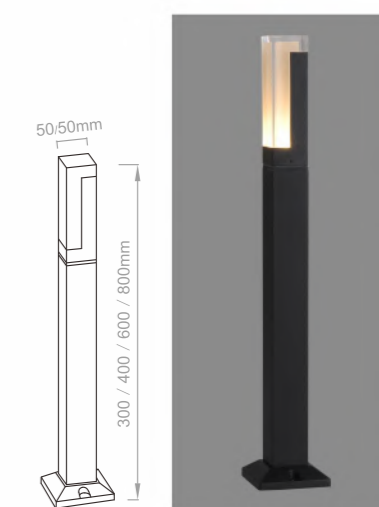

■ 1024D

LED 光源	5W / 500lm
Ra 显指	≥80
Color Temperature 色温	2700K / 3000K / 4000K / 6000K
Fixture Color 灯体颜色	Black / Grey / White / Platinum grey 砂黑 / 砂灰 / 砂白 / 砂咖啡
Input Voltage 输入电压	AC 100-277V
Working Temperature 工作温度	-15°C ~ 50°C
Material 主要材质	Die-casting aluminum / Tempered glass 压铸铝 / 钢化玻璃

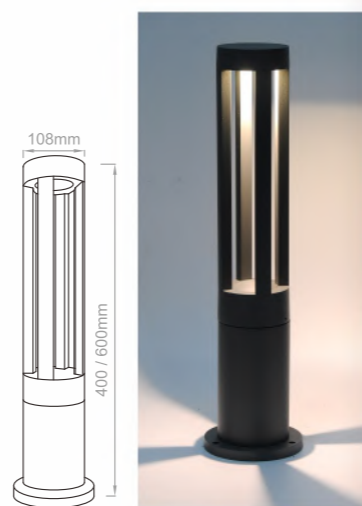

■ 1028

LED 光源	4W / 400lm
Ra 显指	≥80
Color Temperature 色温	2700K / 3000K / 4000K / 6000K
Fixture Color 灯体颜色	Black / Grey / White / Platinum grey 砂黑 / 砂灰 / 砂白 / 砂咖啡
Input Voltage 输入电压	AC 100-277V
Working Temperature 工作温度	-15°C ~ 50°C
Material 主要材质	Die-casting aluminum / PC diffuser 压铸铝 / PC

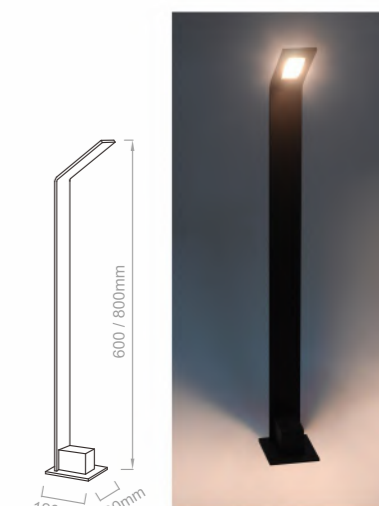

■ Bollard Lighting



■ Bollard Lighting

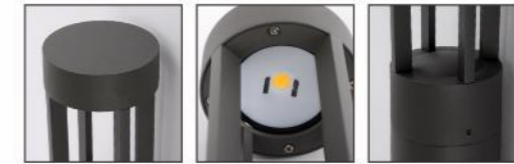

■ 1029D

LED 光源	5W / 500lm
Ra 显指	≥ 80
Color Temperature 色温	2700K / 3000K / 4000K / 6000K
Fixture Color 灯体颜色	Black / Grey / White / Platinum grey 砂黑 / 砂灰 / 砂白 / 砂咖啡
Input Voltage 输入电压	AC 100-277V
Working Temperature 工作温度	-15°C ~ 50°C
Material 主要材质	Die-casting aluminum / Tempered glass 压铸铝 / 钢化玻璃

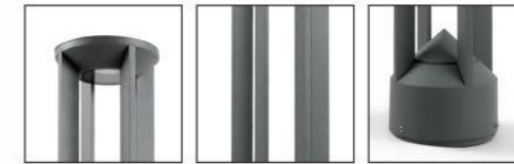
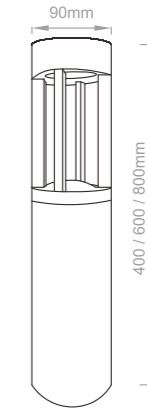

■ 1031

LED 光源	5W / 500lm
Ra 显指	≥ 80
Color Temperature 色温	2700K / 3000K / 4000K / 6000K
Fixture Color 灯体颜色	Black / Grey / White / Platinum grey 砂黑 / 砂灰 / 砂白 / 砂咖啡
Input Voltage 输入电压	AC 100-277V
Working Temperature 工作温度	-15°C ~ 50°C
Material 主要材质	Die-casting aluminum / Tempered glass 压铸铝 / 钢化玻璃

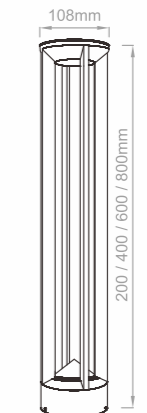

■ 1065

LED 光源	3W / 300lm
Ra 显指	≥ 80
Color Temperature 色温	2700K / 3000K / 4000K / 6000K
Fixture Color 灯体颜色	Black / Grey / White / Platinum grey 砂黑 / 砂灰 / 砂白 / 砂咖啡
Input Voltage 输入电压	AC 100-277V
Working Temperature 工作温度	-15°C ~ 50°C
Material 主要材质	Die-casting aluminum / Acrylic diffuser 压铸铝 / 亚克力

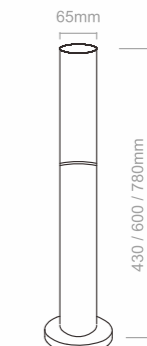

■ Bollard Lighting



■ 1034

LED 光源	5W / 500lm
Ra 显指	≥80
Color Temperature 色温	2700K / 3000K / 4000K / 6000K
Fixture Color 灯体颜色	Black / Grey / White / Platinum grey 砂黑 / 砂灰 / 砂白 / 砂咖啡
Input Voltage 输入电压	AC 100~277V
Working Temperature 工作温度	-15°C ~ 50°C
Material 主要材质	Die-casting aluminum / Tempered glass 压铸铝 / 钢化玻璃

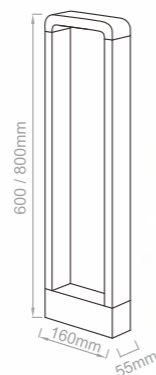

■ 1032A

LED 光源	12W / 1200lm
Ra 显指	≥80
Color Temperature 色温	2700K / 3000K / 4000K / 6000K
Fixture Color 灯体颜色	Black / Grey / White / Platinum grey 砂黑 / 砂灰 / 砂白 / 砂咖啡
Input Voltage 输入电压	AC 100~277V
Working Temperature 工作温度	-15°C ~ 50°C
Material 主要材质	Die-casting aluminum / PC diffuser 压铸铝 / PC

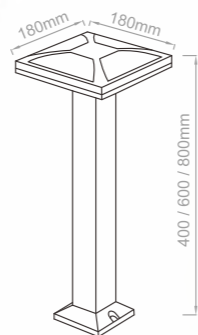

■ 1032B

LED 光源	12W / 1200lm
Ra 显指	≥80
Color Temperature 色温	2700K / 3000K / 4000K / 6000K
Fixture Color 灯体颜色	Black / Grey / White / Platinum grey 砂黑 / 砂灰 / 砂白 / 砂咖啡
Input Voltage 输入电压	AC 100~277V
Working Temperature 工作温度	-15°C ~ 50°C
Material 主要材质	Die-casting aluminum / PC diffuser 压铸铝 / PC

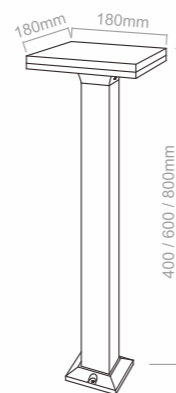

■ Bollard Lighting



■ 1033A

LED 光源	12W / 1200lm
Ra 显指	≥80
Color Temperature 色温	2700K / 3000K / 4000K / 6000K
Fixture Color 灯体颜色	Black / Grey / White / Platinum grey 砂黑 / 砂灰 / 砂白 / 砂咖啡
Input Voltage 输入电压	AC 100~277V
Working Temperature 工作温度	-15°C ~ 50°C
Material 主要材质	Die-casting aluminum / PC diffuser 压铸铝 / PC

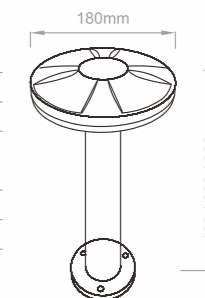

■ 1033B

LED 光源	12W / 1200lm
Ra 显指	≥80
Color Temperature 色温	2700K / 3000K / 4000K / 6000K
Fixture Color 灯体颜色	Black / Grey / White / Platinum grey 砂黑 / 砂灰 / 砂白 / 砂咖啡
Input Voltage 输入电压	AC 100~277V
Working Temperature 工作温度	-15°C ~ 50°C
Material 主要材质	Die-casting aluminum / PC diffuser 压铸铝 / PC

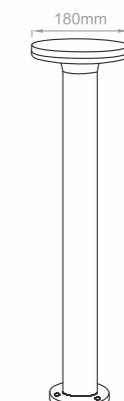

■ 1065B

LED 光源	7W / 700lm
Ra 显指	≥80
Color Temperature 色温	2700K / 3000K / 4000K / 6000K
Fixture Color 灯体颜色	Black / Grey / White / Platinum grey 砂黑 / 砂灰 / 砂白 / 砂咖啡
Input Voltage 输入电压	AC 100~277V
Working Temperature 工作温度	-15°C ~ 50°C
Material 主要材质	Die-casting aluminum / PC diffuser 压铸铝 / PC

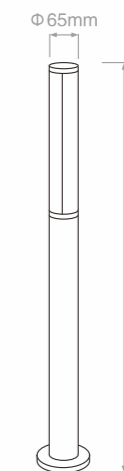

■ Bollard Lighting

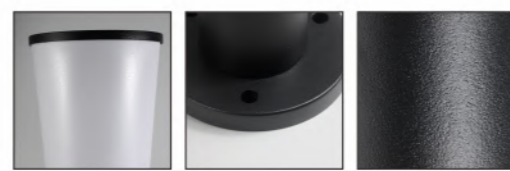

■ 1065T

LED 光源	7W / 700lm
Ra 显指	≥80
Color Temperature 色温	2700K / 3000K / 4000K / 6000K
Fixture Color 灯体颜色	Black / Grey / White / Platinum grey 砂黑 / 砂灰 / 砂白 / 砂咖啡
Input Voltage 输入电压	AC 100~277V
Working Temperature 工作温度	-15°C ~ 50°C
Material 主要材质	Die-casting aluminum / PC diffuser 压铸铝 / PC

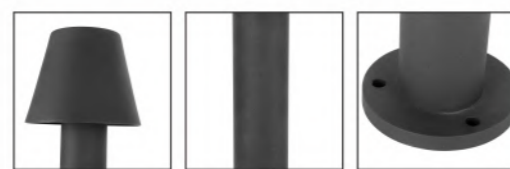
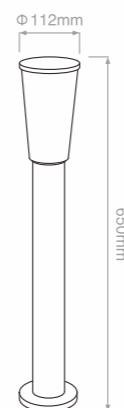

■ 1065Z

LED 光源	5W / 500lm
Ra 显指	≥80
Color Temperature 色温	2700K / 3000K / 4000K / 6000K
Fixture Color 灯体颜色	Black / Grey / White / Platinum grey 砂黑 / 砂灰 / 砂白 / 砂咖啡
Input Voltage 输入电压	AC 100~277V
Working Temperature 工作温度	-15°C ~ 50°C
Material 主要材质	Aluminum / 铝

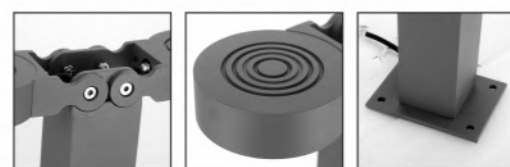
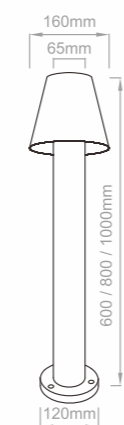

■ 1072

LED 光源	2 × 5W / 1000lm
Ra 显指	≥80
Color Temperature 色温	2700K / 3000K / 4000K / 6000K
Fixture Color 灯体颜色	Black / Grey / White / Platinum grey 砂黑 / 砂灰 / 砂白 / 砂咖啡
Input Voltage 输入电压	AC 100~277V
Working Temperature 工作温度	-15°C ~ 50°C
Material 主要材质	Aluminum / Tempered glass 铝 / 钢化玻璃

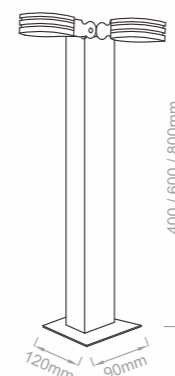

■ Bollard Lighting

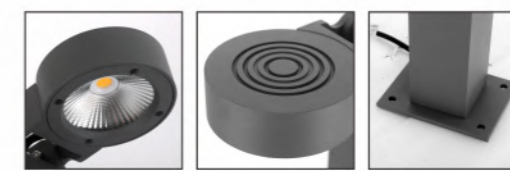

■ 1073

LED 光源	5W / 500lm
Ra 显指	≥80
Color Temperature 色温	2700K / 3000K / 4000K / 6000K
Fixture Color 灯体颜色	Black / Grey / White / Platinum grey 砂黑 / 砂灰 / 砂白 / 砂咖啡
Input Voltage 输入电压	AC 100~277V
Working Temperature 工作温度	-15°C ~ 50°C
Material 主要材质	Aluminum / Tempered glass 铝 / 钢化玻璃

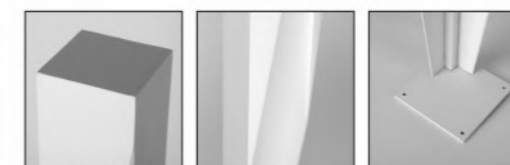
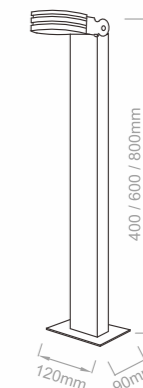

■ 1071

LED 光源	3W / 300lm
Ra 显指	≥80
Color Temperature 色温	2700K / 3000K / 4000K / 6000K
Fixture Color 灯体颜色	Black / Grey / White / Platinum grey 砂黑 / 砂灰 / 砂白 / 砂咖啡
Input Voltage 输入电压	AC 100~277V
Working Temperature 工作温度	-15°C ~ 50°C
Material 主要材质	Aluminum / Lens diffuser 铝 / 透镜



■ 1076

LED 光源	2 × 3W / 600lm
Ra 显指	≥80
Color Temperature 色温	2700K / 3000K / 4000K / 6000K
Fixture Color 灯体颜色	Black / Grey / White / Platinum grey 砂黑 / 砂灰 / 砂白 / 砂咖啡
Input Voltage 输入电压	AC 100~277V
Working Temperature 工作温度	-15°C ~ 50°C
Material 主要材质	Aluminum / PC diffuser / Lens diffuser 铝 / 亚克力 / 透镜

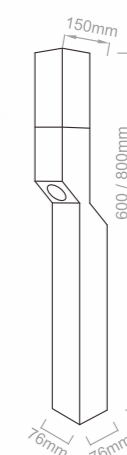

■ Bollard Lighting



■ 1077

LED 光源	3W / 300lm
Ra 显指	≥80
Color Temperature 色温	2700K / 3000K / 4000K / 6000K
Fixture Color 灯体颜色	Black / Grey / White / Platinum grey 砂黑 / 砂灰 / 砂白 / 砂咖啡
Input Voltage 输入电压	AC 100-277V
Working Temperature 工作温度	-15°C ~ 50°C
Material 主要材质	Aluminum / Lens diffuser 铝 / 透镜

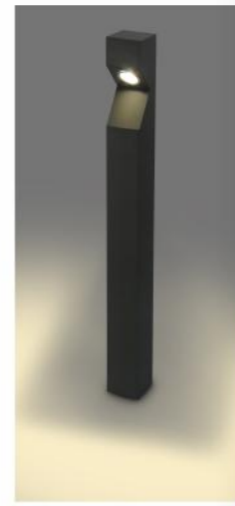
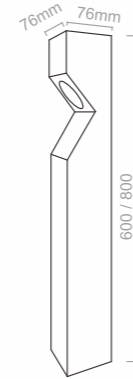

■ Bollard Lighting

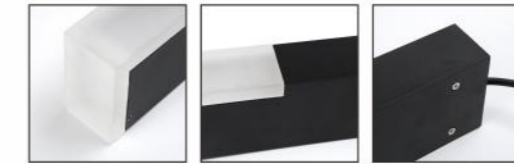

■ 1083

LED 光源	6W / 600lm
Ra 显指	≥80
Color Temperature 色温	2700K / 3000K / 4000K / 6000K
Fixture Color 灯体颜色	Black / Grey / White / Platinum grey 砂黑 / 砂灰 / 砂白 / 砂咖啡
Input Voltage 输入电压	AC 100-277V
Working Temperature 工作温度	-15°C ~ 50°C
Material 主要材质	aluminum / PC diffuser 铝 / 亚克力

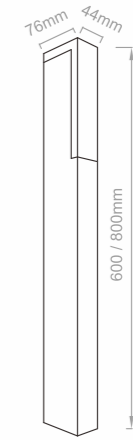

■ 1078

LED 光源	3W / 300lm
Ra 显指	≥80
Color Temperature 色温	2700K / 3000K / 4000K / 6000K
Fixture Color 灯体颜色	Black / Grey / White / Platinum grey 砂黑 / 砂灰 / 砂白 / 砂咖啡
Input Voltage 输入电压	AC 100-277V
Working Temperature 工作温度	-15°C ~ 50°C
Material 主要材质	Aluminum / PC diffuser / Lens diffuser 铝 / 亚克力 / 透镜

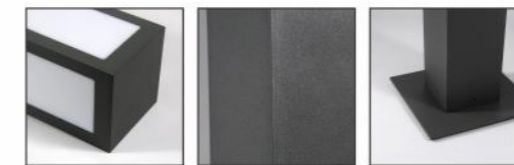
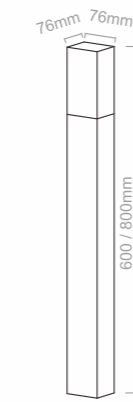

■ 1084

LED 光源	20W / 2000lm
Ra 显指	≥80
Color Temperature 色温	2700K / 3000K / 4000K / 6000K
Fixture Color 灯体颜色	Black / Grey / White / Platinum grey 砂黑 / 砂灰 / 砂白 / 砂咖啡
Input Voltage 输入电压	AC 10-277V
Working Temperature 工作温度	-15°C ~ 50°C
Material 主要材质	Die-casting aluminum / Acrylic diffuser 压铸铝 / 亚克力

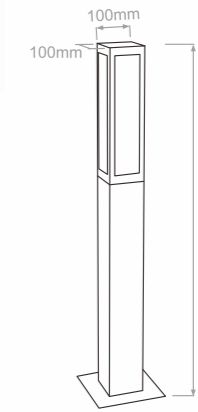

■ 1079

LED 光源	4W / 400lm
Ra 显指	≥80
Color Temperature 色温	2700K / 3000K / 4000K / 6000K
Fixture Color 灯体颜色	Black / Grey / White / Platinum grey 砂黑 / 砂灰 / 砂白 / 砂咖啡
Input Voltage 输入电压	AC 100-277V
Working Temperature 工作温度	-15°C ~ 50°C
Material 主要材质	Die-casting aluminum / PC diffuser 压铸铝 / PC

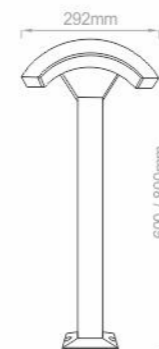

■ Lawn Lighting



■ 1093

LED 光源	1W / 100lm
Ra 显指	≥80
Color Temperature 色温	2700K / 3000K / 4000K / 6000K
Fixture Color 灯体颜色	Black / Grey / White / Platinum grey 砂黑 / 砂灰 / 砂白 / 砂咖啡
Input Voltage 输入电压	AC 100-277V
Working Temperature 工作温度	-15°C ~ 50°C
Material 主要材质	Aluminum / PC diffuser 铝 / 亚克力

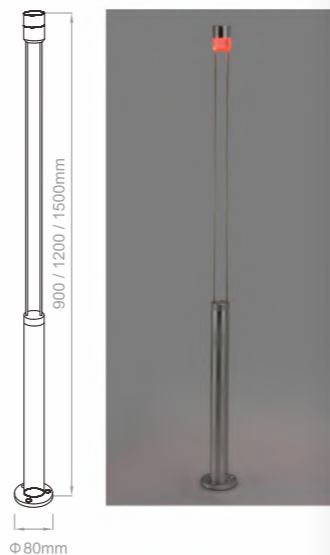

■ 1095

LED 光源	5W / 500lm
Ra 显指	≥80
Color Temperature 色温	2700K / 3000K / 4000K / 6000K
Fixture Color 灯体颜色	Black / Grey / White / Platinum grey 砂黑 / 砂灰 / 砂白 / 砂咖啡
Input Voltage 输入电压	AC 100-277V
Working Temperature 工作温度	-15°C ~ 50°C
Material 主要材质	Aluminum / Stainless steel / Lens 铝 / 不锈钢 / 透镜

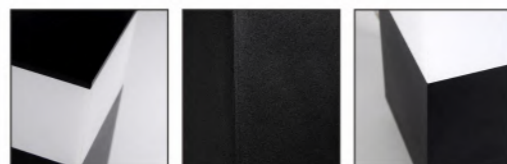
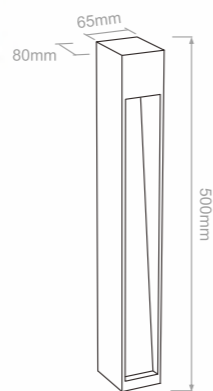

■ 1096

LED 光源	12W / 1200lm
Ra 显指	≥80
Color Temperature 色温	2700K / 3000K / 4000K / 6000K
Fixture Color 灯体颜色	Black / Grey / White / Platinum grey 砂黑 / 砂灰 / 砂白 / 砂咖啡
Input Voltage 输入电压	AC 100-277V
Working Temperature 工作温度	-15°C ~ 50°C
Material 主要材质	Aluminum / Stainless steel / Acrylic diffuser 铝 / 不锈钢 / 亚克力

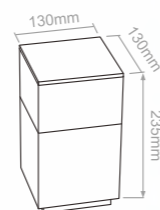

■ Lawn Lighting



■ Lawn Lighting



■ Lawn Lighting

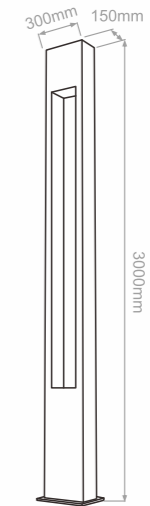
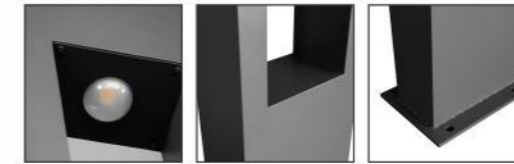

■ 8001

LED 光源	36W / 3600lm
Color Temperature 色温	2700K / 3000K / 4000K / 6000K
Ra 显指	≥80
Fixture Color 灯体颜色	Black / Grey 砂黑 / 砂灰
Input Voltage 输入电压	AC 100~277V
Working Temperature 工作温度	-15°C ~ 50°C
Material 主要材质	Aluminum / Stainless steel / Lens 铝 / 不锈钢 / 透镜

■ Solar Lighting



■ Solar Lighting

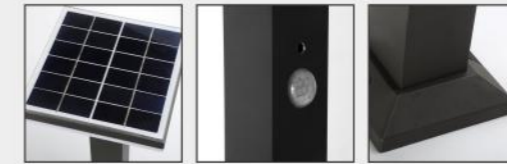

■ S1032

LED 光源	3W / 300lm
Solar plate power 太阳能板功率	5W
Battery capacity 电池容量	4400 / 6600mAh
Ra 显指	≥80
Color Temperature 色温	2700K / 3000K / 4000K / 6000K
Fixture Color 灯体颜色	Black / Grey / White / Platinum grey 砂黑 / 砂灰 / 砂白 / 砂咖啡
Working Temperature 工作温度	-15°C ~ 50°C
Material 主要材质	Die-casting aluminum / PC diffuser Solar plate / Lithium battery 压铸铝 / PC / 太阳能极板 / 锂电池

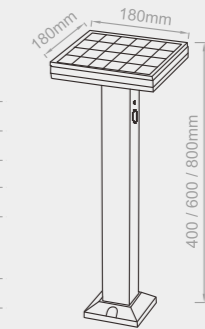

■ S1026

LED 光源	5W / 500lm
Solar plate power 太阳能板功率	5W / 10W
Battery capacity 电池容量	4400 / 6600 / 8800mAh
Ra 显指	≥80
Color Temperature 色温	2700K / 3000K / 4000K / 6000K
Fixture Color 灯体颜色	Black / Grey / White / Platinum grey 砂黑 / 砂灰 / 砂白 / 砂咖啡
Working Temperature 工作温度	-15°C ~ 50°C
Material 主要材质	Die-casting aluminum / Acrylic diffuser Solar plate / Lithium battery 压铸铝 / 亚克力 / 太阳能极板 / 锂电池



■ S2130

LED 光源	5W / 500lm
Solar plate power 太阳能板功率	5W
Battery capacity 电池容量	4400 / 6600 / 8800mAh
Ra 显指	≥80
Color Temperature 色温	2700K / 3000K / 4000K / 6000K
Fixture Color 灯体颜色	Black / White 哑黑 / 哑白
Working Temperature 工作温度	-15°C ~ 50°C
Material 主要材质	Steel / PC diffuser Solar plate / Lithium battery 钢 / 亚克力 / 太阳能极板 / 锂电池

